

Sebestyén Csaba

RULES

of the international CEC
competitions
for organizing, writing and
interpreting itinners, and for
successful racing

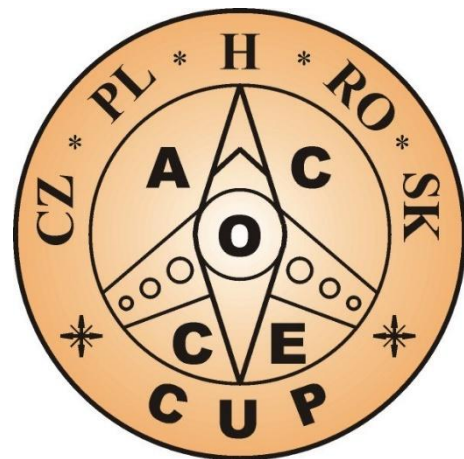

Copyright by PG-ASE, 2010.

The last correction: 2025.

Table of content:

1. **General information**
2. **ROUTE**
3. **MAP**
4. **Route planning on the map**
5. **Navigation on the map**
6. **Navigation based on real information**
7. **Itiner window description**
8. **CONSTANT**
9. **DETAIL**
10. **CONDITION**
11. **INSERT**
12. **SECTION**
13. **SM**
14. **WAA (Walking Around Arrow)**
15. **Delays and penalties**
16. **Examples**
 - 16.1. Navigation on the map from map point to map point – Basics
 - 16.2. Navigation on the map from map point to map point – WAA direction; drive in - out
 - 16.3. Navigation on the map from map point to map point – Crosses and turns
 - 16.4. Navigation on the map from map point to map point – Objects on the map and other signs
 - 16.5. Navigation on the map from map point to map point – Re-planning of the route
 - 16.6. Navigation from real point to real point based on real information – Basics
 - 16.7. Navigation from real point to real point based on real information – Others
 - 16.8. Navigation on the map from real point to map point
 - 16.9. Navigation based on real information from real point to map point
 - 16.10. Navigation based on real information from map point to map point
 - 16.11. Navigation based on real information from map point to real point
 - 16.12. **DETAIL**
 - 16.13. **CONSTANT**
 - 16.14. **CONDITION**
 - 16.15. **INSERT**
 - 16.16. **SM**
 - 16.17. Leaving the map when passing a roundabout
 - 16.18. Other examples of special passings

For examples, the green line indicates the correct path and the red is wrong.
The Norths are not marked separately, always at the top edge of the maps.

1. General information

- 1.1 The following rules must be applied to all competitions in the Central European Cup (CEC); in the Central European Cup (CEC) competitions **only and exclusively** the rules in this Code must be used.
- 1.2 All new ideas and interpretations must be entered into the Rules by 25th February or at least 30 days before the first race of the competition year, with written and visual definitions and explanations. If it has not been included, it can **not be applied** in that year.
- 1.3 In the event of a race, the organizing country can **only use** technical supplement in a written form, extended by visual information and **provided for all competitors separately** (e.g. traffic flow diversion, bad road conditions, special attention required, etc.). It is **NOT ALLOWED** to provide any interpretation of the itiners different from the Rules is .
- 1.4 Every directional information (North, West, East, South, Right, Left, Straight) must be given according to English labels (N, W, S, W), only local abbreviation (R, P, D, etc.) is not allowed.
- 1.5 The documentation of **every stage** (etap) must separately specify:
 - 1.5.1 The number of the etap (e.g.: **1N**)
 - 1.5.2 The name of the creator of the etap (e.g.: **Sebestyén György**)
 - 1.5.3 The time of the etap (e.g.: **t = 100 min**)
 - 1.5.4 The length of the etap (e.g.: **l = 10,5 km**)
 - 1.5.5 The valid rotation order (WAA)on the etap
 - 1.5.6 The number of pages of the documentation (e.g.: **1/3**)
 - 1.5.7 Visual information about the special streets. (*see examples 16.13./2*)
- 1.6 The Central European Cup (CEC) must drive along routes which are defined by the following information, i.e. only the variation of this information can be used:
 - 1.6.1 MAP
 - 1.6.2 CONDITION
 - 1.6.3 CONSTANT
 - 1.6.4 INSERT
 - 1.6.5 DETAIL
 - 1.6.6 SM
 - 1.6.7 WAA (Walking Around Arrow, or rotation order in what follows)

2. ROUTE

2.1 The route is defining the next challenge with simple pictures. you have an example:

2.2. The information in the itiner picture (rectangle or window) that: “do this” or “reach the mentioned point with the appropriate

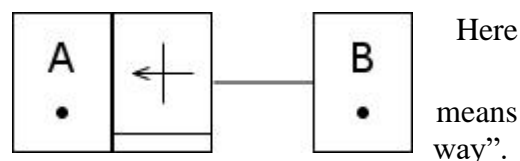

There are two types of itiner pictures:

2.2.1 **Based on map**: you should find the place on the map which described on the itiner picture. Sign: simple rectangle. See the example first itiner picture..

2.2.2 **Based on real information**: you should find the place in the real world which described on the itiner picture without the map. Sign: Rectangle with a line at the bottom part. See the example second itiner picture.

2.3 The sign between the itiner pictures (or the missing sign between rectangles side by side) means that “drives towards” or “approach”.

There are two types of itiner pictures:

- 2.3.1. **Based on map:** you should find the way where you can approach that point on the defined map.
Sign: link (line) between two itiner pictures. See the line between the second and third itiner pictures on the example.
- 2.3.2. **Based on real information:** you should find the way without the map based on real information.
Sign: two itiner pictures side by side without space. See the example between first and second itiner pictures).

3.MAP

3.1

You can find a part of real world on the map. Example:

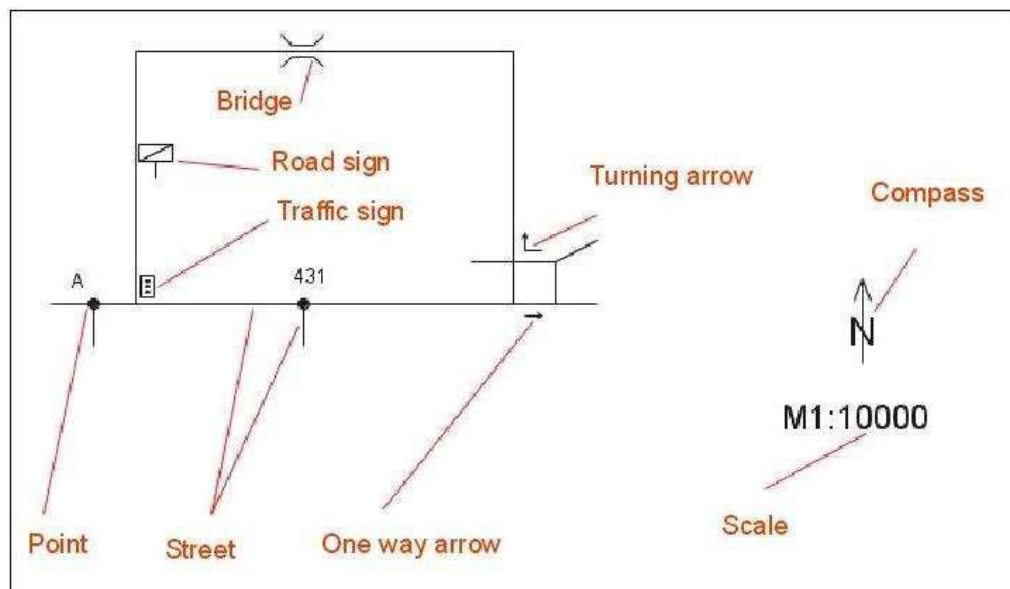

Parts of the map:

3.1.1 **COMPASS:** Mandatory part of the map. You can find one of the four main quarters on the map. The arrow points towards the mentioned direction, the character on the arrow means the first character of the English name of that certain quarter (N: North, S: South, W: West, E: East). In the example, the north is marked at the top edge of the map.

3.1.2 **SCALE:** Also a mandatory part of the map. Usually it is in M1:xxxxxx format which means 1mm on the map means xxxxx mm in the real world. On our examples it is 1:10000 which means 1mm on the map = 10m in the real world. Sometimes short version is also in use: M10 = M1:10000, M20 = M1:20000, M25 = M1:25000, M50 = M1:50000, etc. On the example you can find two points: “A” and “431”.

3.1.3 **STREET:** On the map most of the lines are representing streets. Most of the streets on the map are representing a street in the real as well **but not in every case** (detailed explanation later). Please keep in mind that not all the streets should be visible on the map.

If the itiner said that you should navigate based on map then you should plan your route based on those streets which are visible on the map. On the map those „sticks” are also representing streets which assign to street with only one side.

- 3.1.4 **POINT:** Named location on the map - small black circle with the name :
 - it could be a number (from 1,2, ... 99) or capital letter (A ÷ Z) - through these points it is possible to drive, if their passing is entered in itinerary only.
 - it could be a three digit number (from 100,101, ... 999) - through these points it is possible to drive always, if you look for the shortest path.
 The example shows two Point A and Three Number Point 431.
- 3.1.5 **ONE WAY ARROW:** If there is a “one way arrow” on the map it means that that street is a one way street based on map information (it’s not necessary to have one way street in the real either!). This one way section is reasonable only between two crosses. When we are travelling based on map information then we should go through on this section as indicated by one way arrow.
 On the example the street east from point 431 only a small section is indicated as one way street, so we can go through on that section only from west to east direction but on the other parts of that road we can travel as we want.
- 3.1.6 **TURNING ARROW:** It’s connecting to the cross (not for part of the street as one way arrow), so it’s drawn next to the cross on the map, not between two crosses. Meaning of turning arrow: when we arrive to the cross from the leg of the arrow then we must move towards that street which pointed by the arrow but if we arrive from any other direction then turning arrow is not relevant for us, so we can travel as we want. It’s similar than “compulsory heading” road sign.
 On the example if you arrive from the East to that cross then you must turn to the North.
 In some cases turning arrow mystify you because it would sign that you should move forward in a cross (e.g. from South to North). In this case the leg of the arrow is straight and for first sight you don’t know that it will be a turning arrow.
 If you have a more complex cross (e.g. delta cross) then turning arrow could overlap more crosses.
- 3.1.7 **BRIDGE, ROAD SIGN, TRAFFIC SIGNAL:** Several objects should be marked on the map as well. As in case of streets those shouldn’t be available objects in the real world as well.

4. Route planning on the map

If you need to find a way on the map between two itiner pictures (or from the actual position of the car) to a certain point or to a certain cross or to a certain object then you should follow the rules below:

- 4.1 You cannot plan route which is turning around in the street, you cannot pass the street in that direction where you have arrived;
- 4.2 Among available planned routes you should choose the shortest one (that is the shortest route which length is at **least 20% shorter** than the second one or you can choose the shortest route based on basic geometric rules – **triangle and circle**). (see examples 16.1./1 and 16.1./2)

- 4.3 Your planned route should be in harmony with turning and one way arrows
(see examples 16.1./3, 16.1./4, 16.1./5 and 16.1./6)
- 4.4 The planned route cannot go through points which marked with characters or one or two numeral digits (see examples 16.1./7 and 16.1./8)
- 4.5 Your planned route should be in harmony with CONDITIONS (if any).
- 4.6 If you need to go from one point to the same point or if you need to go from one point to the other point and you can find two ways with the similar length, then you must plan your route according to the roundabout direction. (see examples 16.2./1, 16.2./2, 16.2./3 and 16.2./4)
- 4.7 If we should plan a route to a dedicated cross (instead of certain point) or a dedicated object then you should choose the nearest of those ones (you should plan your route to the nearest object/cross on the map not on the air). (see examples 16.1./9 and 16.1./10)

5. Navigation on the map

After you planned your route on the map you should going through on the planned route. Sometimes it is not possible because you should re-plan your route according to the actual road signs or traffic rules.

Possibilities are listed below:

- 5.1 Road sign, continuous white line or other sign are not allow to go through on the planned route (see examples 16.5./1-2, 16.5./6-7)
- 5.2 Checkpoint sign gives real information to you (e.g. turn around)
- 5.3 Street marked on the map is not available in the real world ⁽¹⁾ (see examples 16.5./3-5)
If any listed case occurred then you have two possibilities:
- 5.4 You are on the street which is not marked on the map, you should drive according to the rules of navigation based on real information until you will be on a street or at the cross again which is listed on the map. In this case you should re-plan your route from the actual position of car. (see examples 16.5./6)
- 5.5 Still you are on the street or at the cross which is marked on the map. In this case you should re-plan your route from the actual position of car and you should plan with those real information (**only the information, that made you replan**) which is available for you at your current location (e.g. at the cross you can see the road signs, etc.) but those real information which collected earlier are not allowed to use during re-plannin. (see examples 16.5./1-5, 7)
- 5.6 **There must be a correlation on the maps with start/finish !!!**
- 5.7 **A map roundabout is a set of smaller intersections with a specified direction of entry.**





(1) Sometimes the organizers are marked street on the map which not available in the real world. The most difficult thing is to recognize these “not available” streets. It is possible to have a similar street in that area but real distance from the cross and measured distance on the map are different.

How we can decide that is only a measurement error or a “not available” street?

The solution is simple just draw the street to the map according to the measures. If the distance between the original street and our drawn street is smaller than 5mm then it should be a measurement failure. (This is 50m differences in M10 scale, 125m in M25, etc.) If street is starts from the right point but not in the marked direction than we should talk about measurement error only that case if the differences between real and marked direction is smaller than 20°.

6. Navigation based on real information

If you should move to a certain place according to real information without map then you should follow the rules below: *(see examples 16.6.)*



- 6.1 If driving is straightforward because road signs allow only one way then you should go there (e.g. „compulsory heading” or “no entry” sign).
- 6.2 We are travelling on the street until we have notice that we are at the proper cross.
- 6.3 When we are travelling on main road and arrive to a cross (road sign is indicate the continuation of main road) then we should follow the main road.
- 6.4 Every other case we should move straightforward.
- 6.5 In the case competitors arrive to a crossroad, which is marked with  or , exit from this route must be entered always. If we can't continue our route based on previous rules, because we arrived from minor road to a cross where no road straightforward or crossroad is marked with  or  and the exit is'nt entered, then we are on the wrong route. During navigation based on real information, you can't turn around, except special sign instruct you for this action. (e.g. checkpoint sign).
- 6.6 **A real roundabout is a set of smaller intersections with a specified direction of entry.**

7. Itiner window description

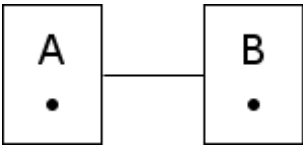
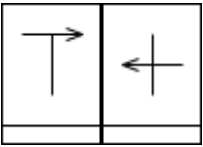
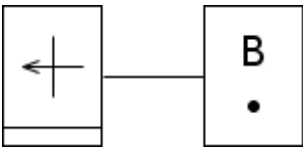
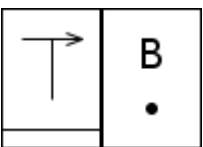
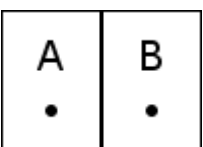
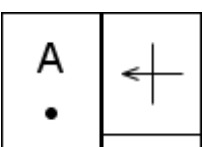
7.1 There should be six combinations of itiner pictures:

Name:	Sign:	Description:
navigation on the map from map point to map point:		From POINT A to POINT B we plan a route on the map and drive according to the rules of navigation on the map and our planned route. If there is a number or character on the line between two itiner pictures then you should plan your route on that map which indicated by that number or character. <i>(see examples 16.1.- 16.5.)</i>
navigation based on real information from real point to real point:		When we have turned right at the T-cross we should travel according to the rules of navigation based on real information until we will be in a full-cross and we should turn left there. <i>(see examples 16.6., 16.7.)</i>
navigation on the map from real point to map point:		When we turned left at the (full-) cross we should plan a route in the map to POINT B and drive according to the plan. <i>(see examples 16.8.)</i>
navigation based on real information from real point to map point:		When we have turned right at the T-cross we should travel according to the rules of navigation based on real information until we will be in POINT B on the map. <i>(see examples 16.9.)</i>
navigation based on real information from map point to map point:		When we have arrived to POINT A on the map we should travel according to the rules of navigation based on real information until we will be in POINT B on the map. <i>(see examples 16.10.)</i>
navigation based on real information from map point to real point:		When we arrived on the map to POINT A we should travel according to the rules of navigation based on real information until we will be in a full-cross and we should turn left there. <i>(see examples 16.11.)</i>

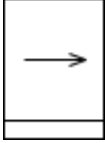
7.2. Itiner pictures in real may have:

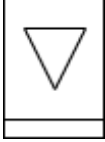
Name:	Sign:	Description:
direction statement		At the next cross where you have possibility you should move forward according to the stated direction (left, right or straightforward). It is independent from the type of the cross. If you have more crosses at the stated direction you should choose the nearest one from that direction where you have arrived to the cross.
real cross type		If you drive according to this information then you should find a cross which has the same type as stated on the picture (T-cross in this case). You will arrive to the cross from the bottom side of the picture (except if a full spot indicate the arrival direction) and turn towards the arrow.
object		You should drive until you will find the stated object (e.g. if you need to find a bridge then you should go through on that, if it's a road sign then you should pass the road sign).

7.3 Observe the following rules:



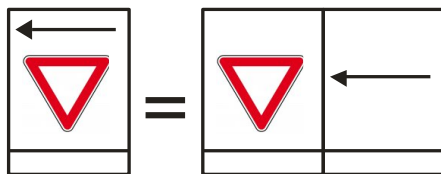

- 7.3.1 This insert or real information (for example) applies generally to all types of traffic sign (all combination with other traffic signs or additional tables).
- excluding of a certain combination is possible by using a constant (*see examples 16.13.*)
 - it is possible to use the exact shape (combination) of traffic sign - (*see examples 16.13.*)
 - the marking of traffic signs with a column and without a column is thereby canceled

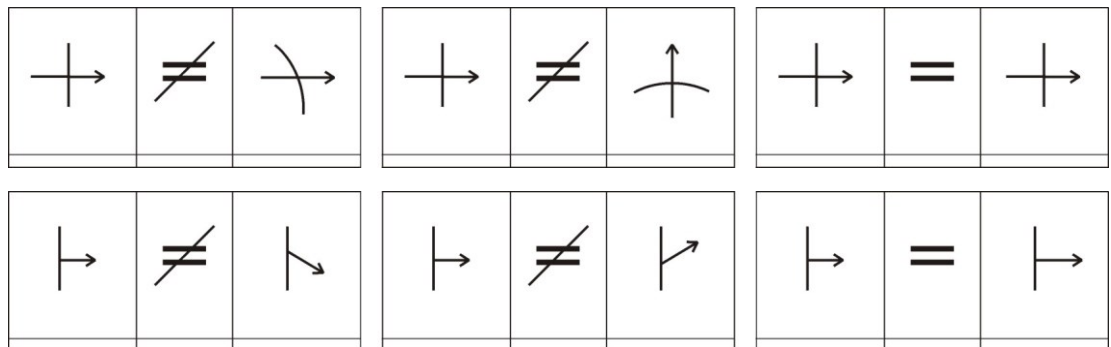

7.3.2 The realistically drawn road junctions are the same as those of intersection.

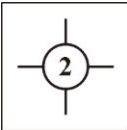

7.4. Itiner pictures on the map may have:

Name:	Sign:	Description:
direction statement		At the nearest cross on the map where you have possibility you should move forward according to the stated direction (left, right or straightforward). Those crosses where you have mandatory leaving direction (e.g. turning arrow) are not counted as cross.
cross type on the map		At the nearest cross which has the same type on the map and you has possibility you should move forward according to the stated direction. There is a possibility to define the arrival or leaving direction if those are not defined then we can choose as we want (of course we should plan
POINT on the map		We should arrive to the mentioned POINT from the stated direction, similar as arrival to the cross.
roundabout on the map		The marked map roundabout indicates that on the map planned, i must leave the map roundabout:
object on the map		We should arrive to the nearest object on the map and pass that.

7.4.1 It is always necessary to look for the first opportunity to draw on the map.

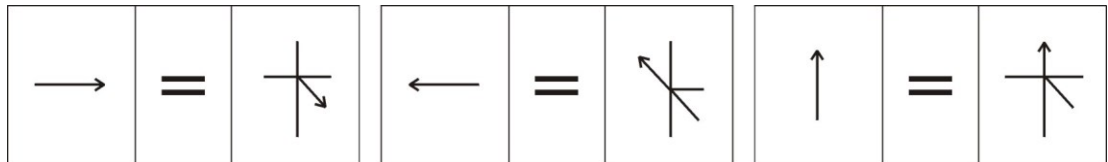

7.4.2 Specify the orientation of map itineraries:

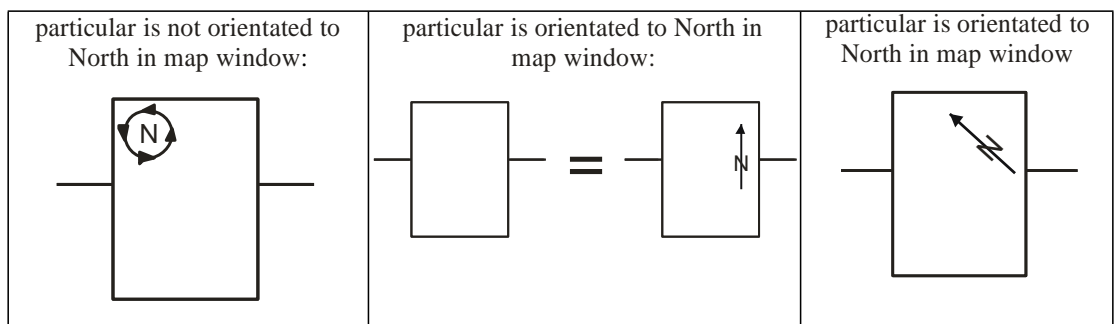

8. CONSTANT

8.1 Constants are general rules which available for the whole etap. Most of the cases constants are defining road sign in proper way. Rotation order (or roundabout direction) is also a special constant. *(see examples 16.13.)*

9. DETAIL

- 9.1 Detail is an enlarged piece of the map. Most of the cases it is describe a more complex cross and its surroundings. All the signs on the detail are valid for all the maps. At least one common POINT must be available between detail and map to fit map with detail. If no other scale then detail is in M1:10000 scale. *(see example 16.12/1)*
- 9.2 All the roads must be noted on the detail which is under the detail area. All connection roads must be visible in case of each cross on the detail.
- 9.3 **The detail drawn in the itinerary or in the map documents applies to all map documents within the given stage. The only exception is the detail that is drawn in the section and therefore only applies to the given section within the given stage.** *(see examples 16.12/2,3,4)*

10. CONDITION

- 10.1 Condition is define a term which should be keep in mind when you are planning your route on the map. *(see example 16.14.)*
- 10.2 There are several types of conditions:
- 10.2.1 **Referring to certain map POINT:** when we arrive the POINT on the map we should go according to the stated rule. *(see example 16.14./1-2).*
- 10.2.2 **Referring to sign on the map:** when we pass that stated sign on the map we should execute the provided commands. *(see example 16.14./4-6).*
- 10.2.3 **Referring to a certain part of the itiner:** Between two itiner picture during the route we should travel according to provided rules. *(see example 16.14./3).*

Example:

CONDITION:

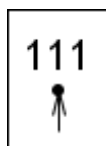

In this case we should arrive to POINT 111 only from South.

10.3 CONDITION must be unambiguous and the validity of CONDITION must be clearly defined always.

There are four cases, how we can write the condition :

10.3.1 The first case is in the top of the itinerary, which is valid for the whole stage. *(see example 16.14./7)*

10.3.2 The second case is in the section of stage, which is valid only for this section. *(see example 16.14./8)*

10.3.3 The third case is next to the map, which is valid only for this specific map, where is this condition written. In this case, when I'm driving through the SM, I don't need to execute this kind of condition, because SM is another map. *(see example 16.14.9)*

10.3.4 The fourth is at the SM, which is valid only for this SM – at leaving of SM and returning to SM is insert not valid. *(see example 16.14./10)*

10.4 It is very important to know that you should use CONDITION information **ONLY** when you are travelling according to the map.

11. INSERT

- 11.1 Insert is a special instruction which should be added to the route before finishing the actual route. **Insert must start on real data.**
- 11.2 Insert all the time defines that WHEN and WHAT should be added to the route. WHEN should be arrival to a certain point, pass a certain road sign, reach certain distance or other

thing. Most of the cases the WHEN is answered in the itiner picture.

11.3 When we have executed the insert command we can move forward according to our original plan. *(see example 16.15.)*

11.4 Big difference between CONDITION and INSERT :

CONDITION - I have to consider it in advance when solving a map passage between two map-places

INSERT - I do not consider it in advance when solving a map passage

(see example 16.15.)

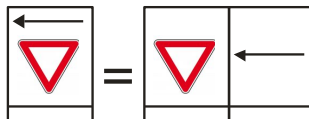
 Example: INSERT In this case when we arrive to the mentioned road sign we should turn left at the first possibility (most of the cases it is the cross at the road sign but not in all cases).

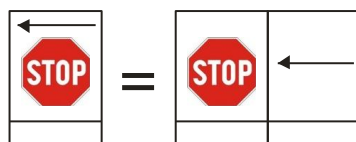
 - behind each traffic sign "STOP" always turn left

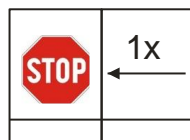
 - behind each traffic sign "STOP" first time turn left

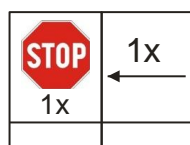
 - behind first traffic sign "STOP" first time turn left

 - behind traffic sign of this type turnright after 0,30 km

11.5 Execution of two and more inserts in one place (cross) in one time is not allowed. All inserts have equal priority. Next insert can be executed after ending execution of previous insert.

11.6 INSERT must be unambiguous and the validity of INSERT must be clearly defined always.

There are four cases, how we can write the insert :

11.6.1 The first case is in the top of the itinerary, which is valid for the whole stage. *(see example 16.15./9)*

11.6.2 The second case is in the section of stage, which is valid only for this section. *(see example 16.15./10)*

11.6.3 The third case is next to the map, which is valid only for this specific map, where is this insert written. In this case, when I'm driving through the SM, I don't need to execute this kind of insert, because SM is another map. *(see example 16.15./11)*

11.6.4 The fourth is at the SM, which is valid only for this SM – at leaving of SM and returning to SM is insert not valid. *(see example 16.15./12)*

12. SECTION

12.1 In some cases CONDITION or INSERT is valid only for a certain part of the route not for the whole route. So, we should drive according to the mentioned rules on a certain part of the etap but during the rest of the etap we should bypass those rules.

Example: In this example we should drive according to INSERT1 rule from POINT A to POINT B. When we arrived POINT B we should drive without INSERT1 rule.

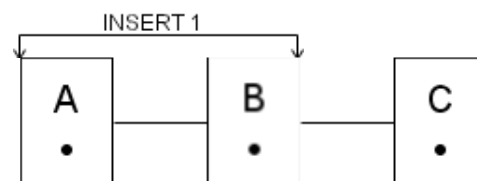

13. SM

- 13.1 SM is defining a route with graphic way where we should going through on the stated direction. SM is independent from the maps, so we should bypass the signs of maps. Some cases during SM section we should travel on those streets which are not marked on the map.
- 13.2 At least four basic data belongs to SM: scale, compass, arrow indicating the direction of passage and one POINT on the map to fit SM to the map. In some cases, may be the direction arrow SM replaced by an arrival direction arrow drawn at the beginning of the SM or an exit direction arrow drawn at the end of the SM or both arrows simultancously. The direction of exit from the SM can also by entered with real itiner picture.
- 13.3 SM always starts and ends at intersections - for example, at an intersection where the direction of extinction is not clear. If the direction of extinction is not specified, i should really leave the intersection (for example, go straight ahead).
- 13.4 Often it is necessary to interrupt SM implementation (for example, an INSERT statement or a traffic rule). Then you have to go back to the interruption and then continue the SM.

Rules of arrive back to the interruption:

- 13.4.1 It is not allowed to drive on the route of SM,
- 13.4.2 It is not allowed to drive against the SM direction,
- 13.4.3 It is allowed to cross the SM route,
- 13.4.4 You must plan your route back to the interruption point on BASE MAP. *(see examples 16.16.)*

13.5 Inserting points and objects into the base map using SM. All points and subjects (exam. bridge, traffic sign, etc.) located on the SM will after ride out inserted into the basic map, except arrows. The inserted points and objects from insertion apply until the end of the stage. *(see examples 16.16./6)*

13.6 If the arrival to the SM is entered real, we can have two options.

Situation 1: If SM doesn't begin in the point on the map, we must start execution of this SM in the nearest crossroad, where is not crossroad with a unambiguous real exit. In this case does not have to SM contain a point, which SM places to the map. *(see examples 16.16./7)*

Situation 2: If SM starts in the point on the map, we must go by the real instructions to this point and start execution of this SM in this specific point. *(see examples 16.16./8)*

13.7 Drawing SM into map. *(see examples 16.16.)*

13.8 If the SM begins or ends at a point or dimension, that point or dimension must be indicated on the SM. *(see examples 16.16./13)*

14. WAA (Walking Around Arrow)

- 14.1 If you need to go from one point to the same point or if you need to go from one point to the other point and you can find two ways with the similar length then you must plan your route according to the roundabout direction - if it is not influenced by any other circumstance - where I plan the way, clockwise or in a counterclockwise direction.
(see examples 16.2./1, 16.2./2, 16.2./3, 16.2./4 and 16.2./5)

For example: here clockwise same way

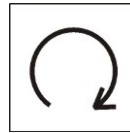

15. Delays and penalties

Delay time limit:

- One stage – maximum delay = 45 minutes
- Two stages – all maximum delay = 60 minutes (maximum delay is 45 minutes/etap)
- From three stages – all max. delay = 90 minutes (maximum delay is 45 minutes/etap).

Penalties of delays:

- 1 – 10 minutes delays on stages = every minute is 5 points
- 11 – 45 minutes delays on stages = every minute is 10 points
- From 46 minutes = every minute is 500 points – one stage – for each stage
- From 61 minutes = every minute is 500 points – two stages – for a two stages
- From 91 minutes = every minute is 500 points – three stages - for a three stages
- After 15 minutes of maximum delay of crew, which started last – in the every night/day stage – time control can be canceled and every crew, which arrive after the time control cancelation will get 7500 + 10000 penalty points – organizer will not wait for crews on track for a longer time.

Penalties during stages:

- Plus check point = 60 point / piece
- Minus check point = 100 point / piece
- Radar = 10 point / 1km/h, over speed limit

Penalties during technical race:

- Spent time on technical race course converted to points with the following ratio: 1 second = 2 points.
- Roll over or move cones: 10 points / each.
- Roll over or move cones at the start (typically in Slovakia and Czech Republic where big cones located around the car): 15 points / each.
- Missed gates during slalom (2 gates) : 10 points / each.
- Missed gates during slalom (more as 2 gates) : 50 points - wrong sequence of tasks
- Wrong arrival to the finish line (e.g. wheels should be between lines, wheels should be in square, line should be between rears): 15 points.
- Failure in task accuracy (e.g. wrong arrival to the finish line as described before, missed gates during slalom): 15 points / each.
- Failure of other tasks (e.g. narrow gates, rears have pass certain cones before reversing): 15 points / each.
- Open window on navigator side: 50 points.
- Opened door during technical race: 50 points.
- Wrong order/sequence of tasks: 50 points.
- Skip element during technical race or missed 3 or more gates during slalom: 50 points.
- Garage is a special/double task (you can get 0, 15 or 30 points during this session):
 - At the end of garage you should reach small cones. If you are not able to reach/touch small cones or if you touch big cones at the end of garage: 15 points.
 - If you touch one or more side cones (even all): 15 points.
- Unfinished technical race or impossible to start due to technical reason: points of last crew + 50 points



16. Examples

During examples the green line means the correct route the red one means the incorrect route. On the maps you can find North direction towards the upper edge of the map.

16.1. Basics – navigation on the map from map point to map point

During this example you should plan a route between two map

POINTS. The itiner is :

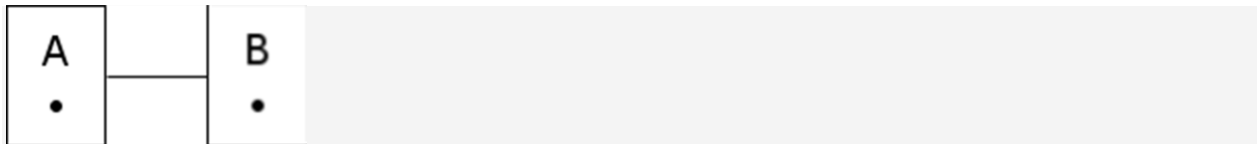

1a. Example:

Map is:

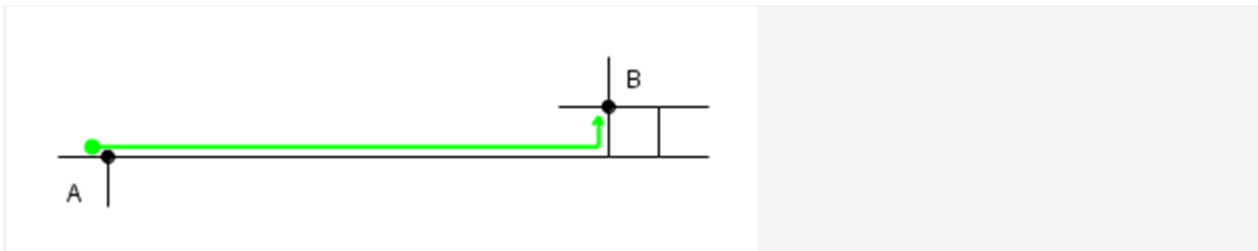

This is a very simple situation: From point A you can choose the shortest route to point B based on geometric rules: one side of the square is shorter than the other three together, so you don't need to go round of the square.

1b. Example:

Determining the shortest route with a difference of more than 20%

the shortest route with a difference of more than 20% between point A and point B is determined from place 1 to place 2 (without common parts 1 and 10)

alternative a1 = 2+3+4+5+6

alternative a2 = 7+8+9

if a is between a1 and a2 a difference of more than 20% - we have the shortest route between point A and point B

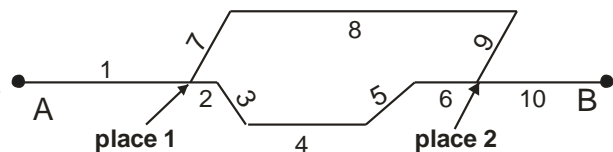

2. Example:

Map is:

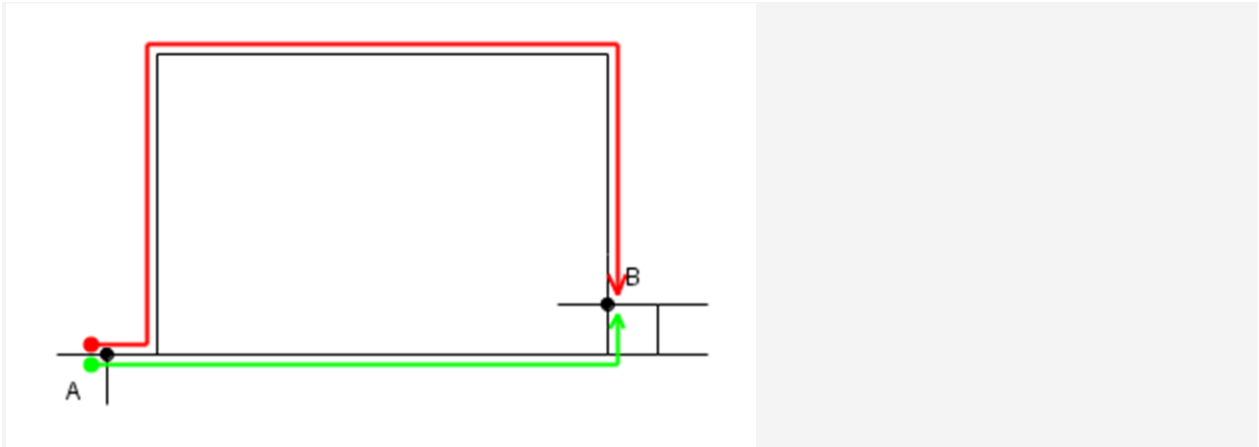

In this case you can choose between more routes but when you measure the possibilities you will see that the red one is longer than the green one.

3. Example:

Map is:

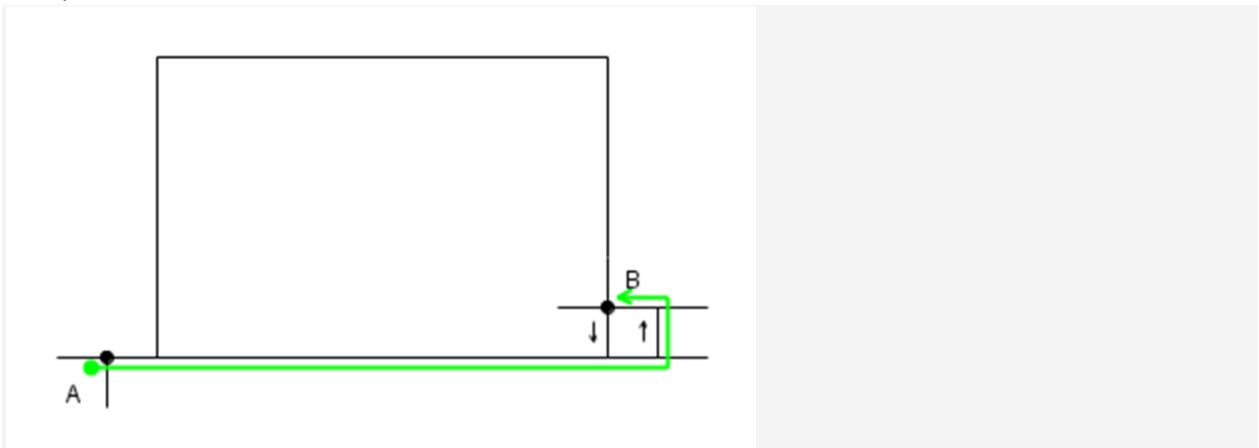

You can see the usage of one way streets (one way arrows) in this example. You cannot plan a route which going against one way arrow.

4. Example:

Map is:

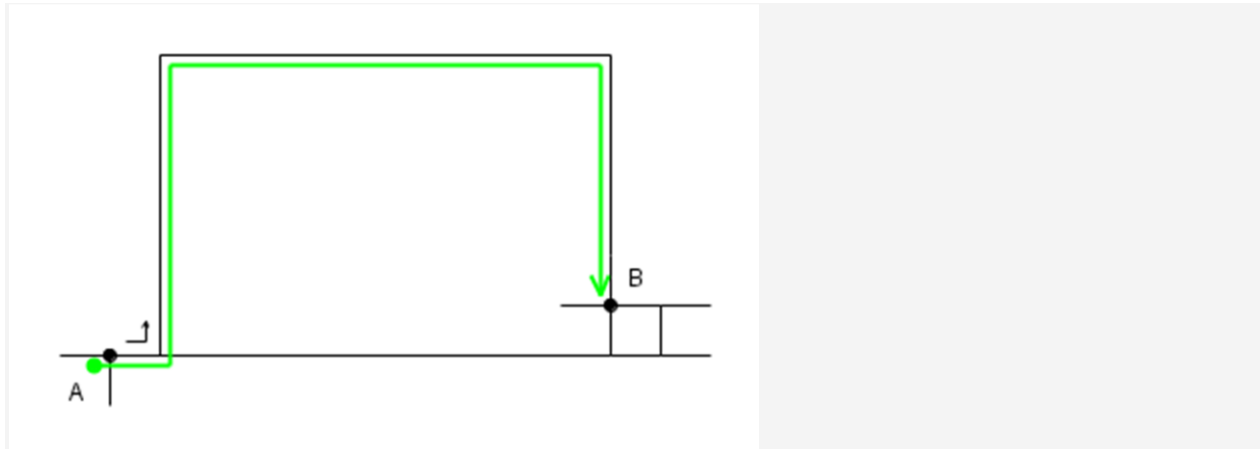

You can see the usage of turning arrow in this example. You have no any other possibility only the green one.

5. Example:

Map is:

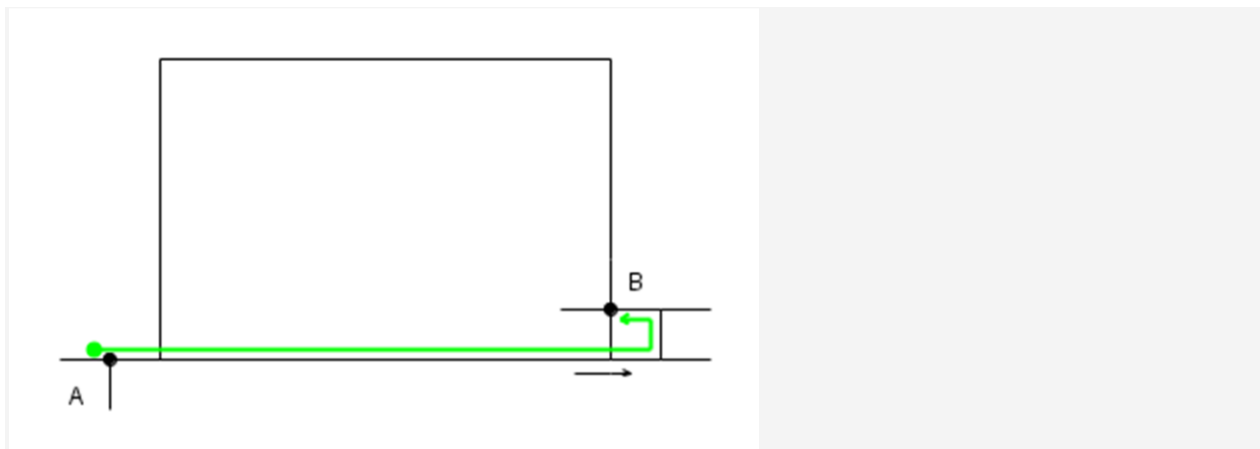

You have more possibilities in this example but together with turning arrow (which in this case means that you should move straightforward in that cross) the marked route is the shortest one.

6. Example:

Map is:

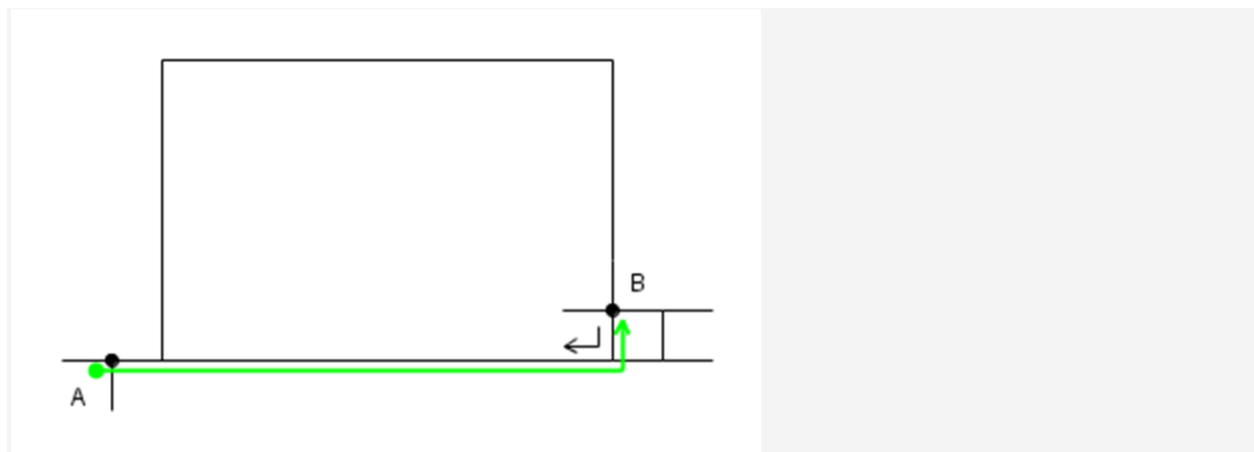

You can drive according to the turning arrow if you arrive from the leg of the arrow, otherwise you can turn as you wants.

7. Example:

Map is:

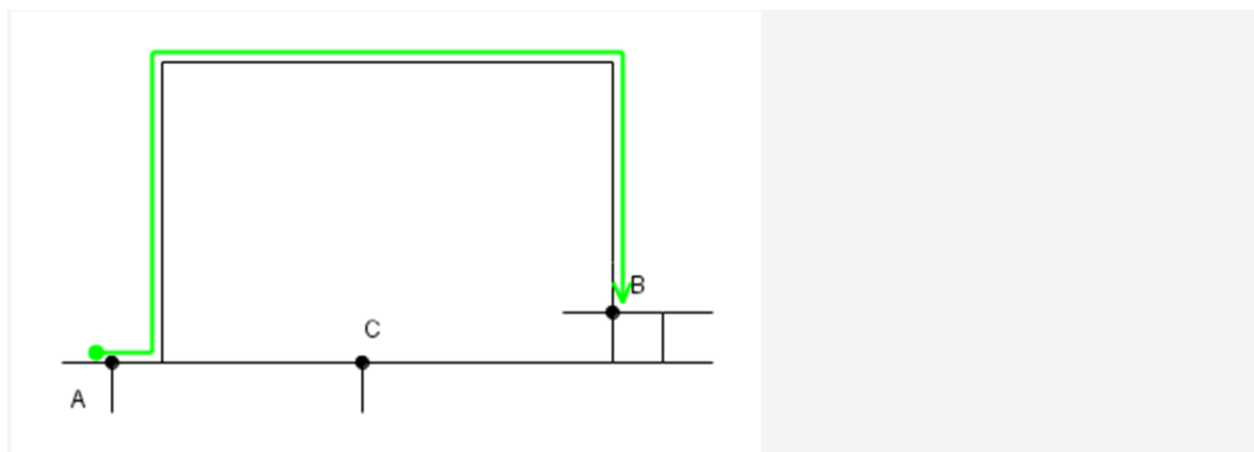

You cannot plan a route through POINT C if it is not specified in the itiner.

8. Example:

Map is:

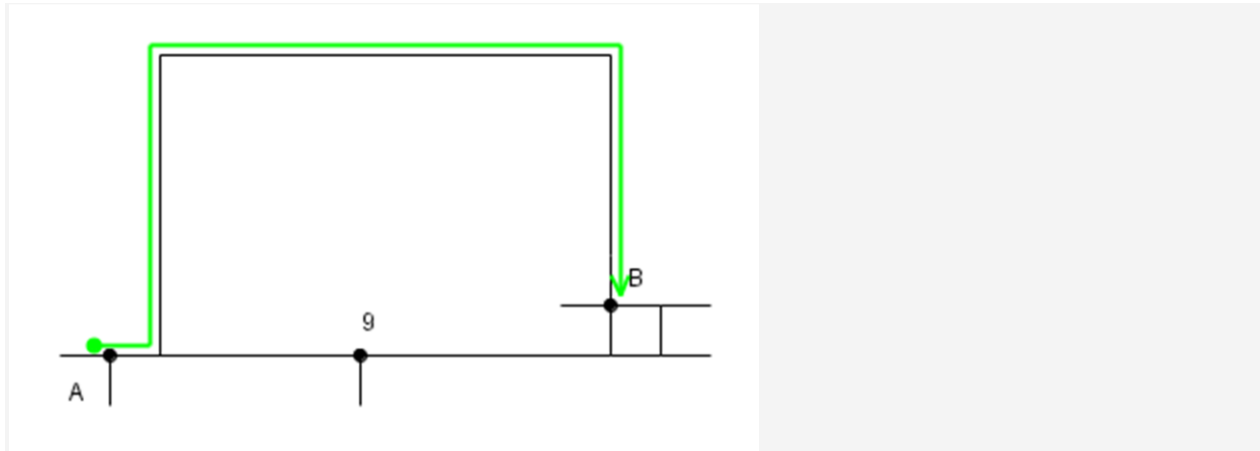

The same rule should be applied in case of one or two numeral digits as well.

9. Example:

Map is:

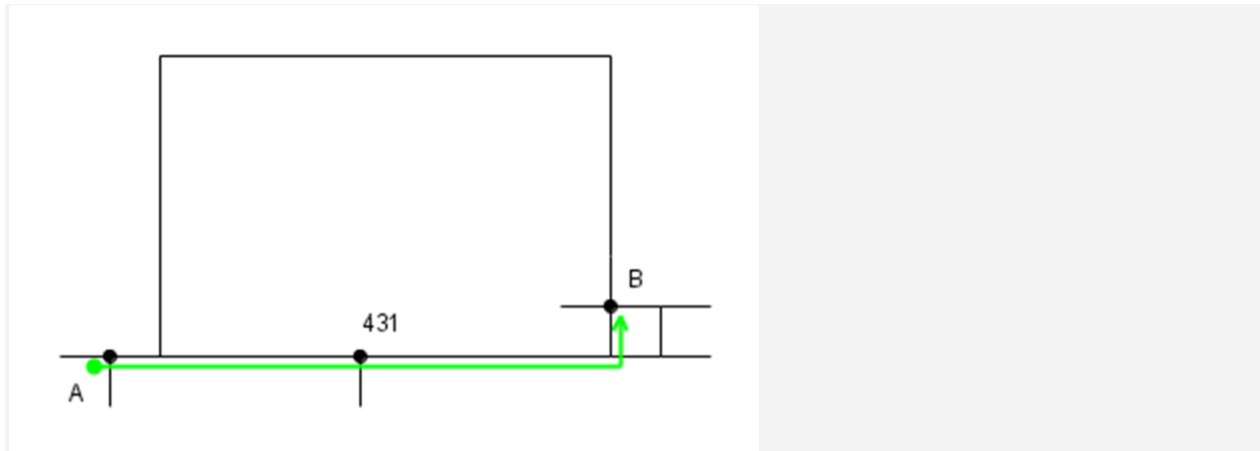

You can plan a route through POINT which marked with three numeral digits.

10. Example:

Street below a bridge on the map:

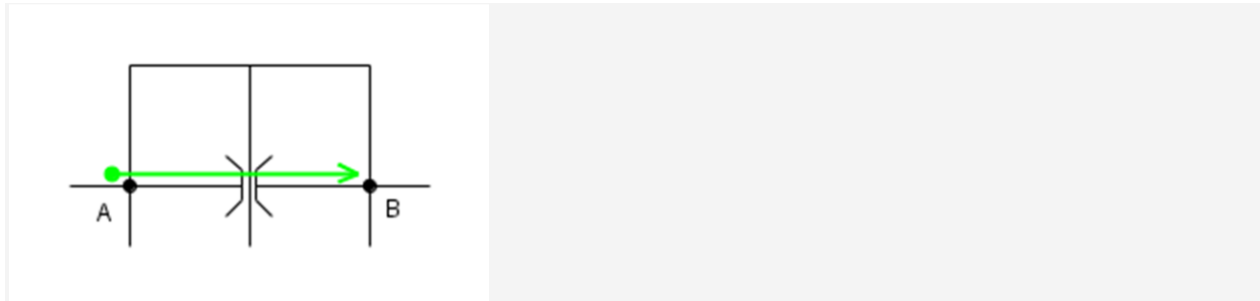

When the streets on the map are attached to the sides of the bridge then you should consider that street as a continuous street. It means that in the example you can plan the shortest route on the map from POINT A to POINT B under the bridge.

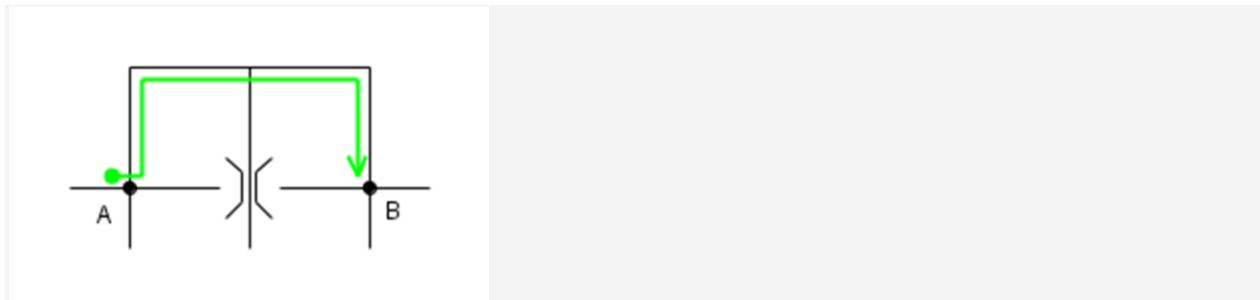

When the streets on the map are not attached to the bridge it means two independent streets on the map, so you cannot plan a route from POINT A to POINT B

11. Example:

When you go by the map - must exist map route allways (can not be predicted change of route by some real information) :

the correct map route

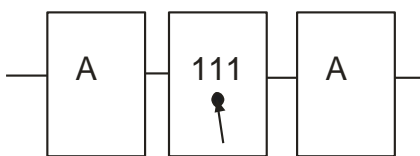

or

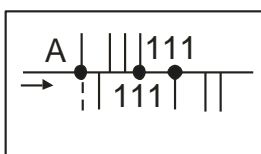

map :

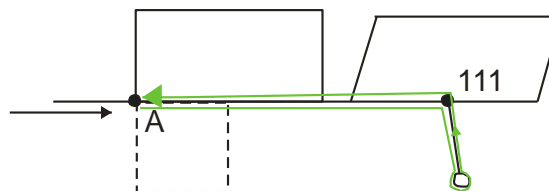

real :

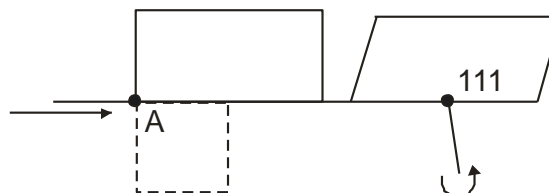

the incorrect map route

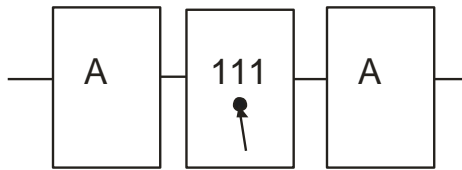

or

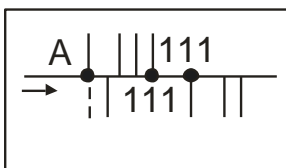

map :

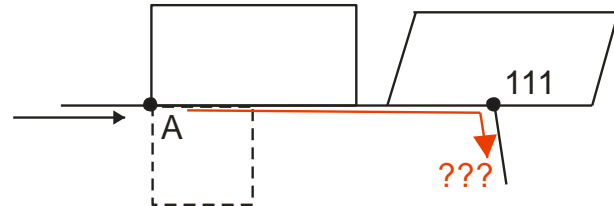

real :

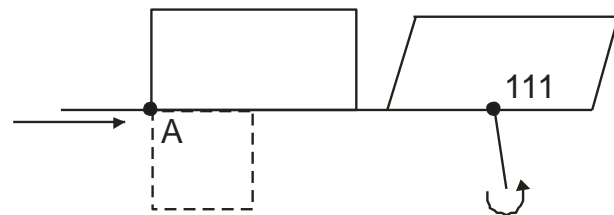

16.2. Roundabout direction; drive in - out; navigation on the map from map point to map point

1. Example:

We will show the usage of "roundabout direction" (or rotation order).

The itiner is:

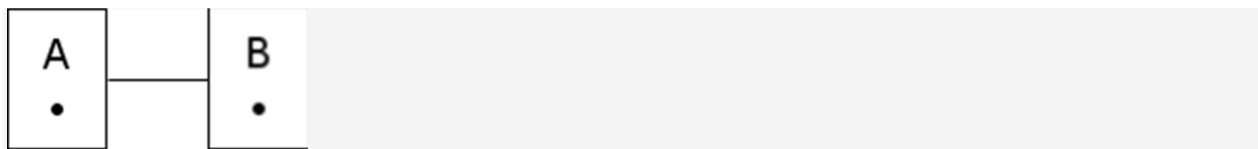

Roundabout direction is:

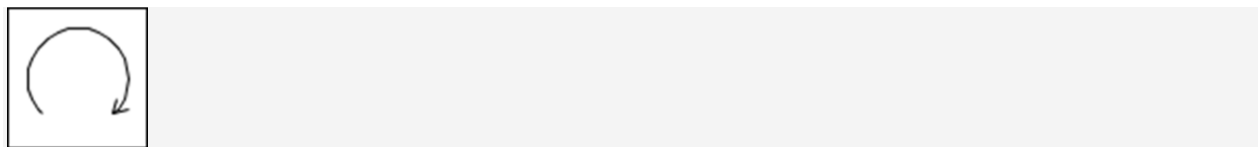

It means that you should plan a route on the map from POINT A to POINT B and if you can find two routes which has the same length then you should drive according to the roundabout direction.

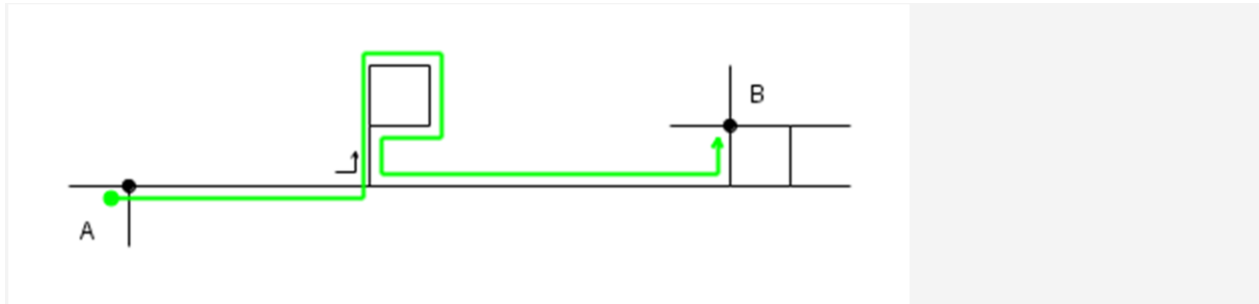

2. Example:

Other example for roundabout direction usage:

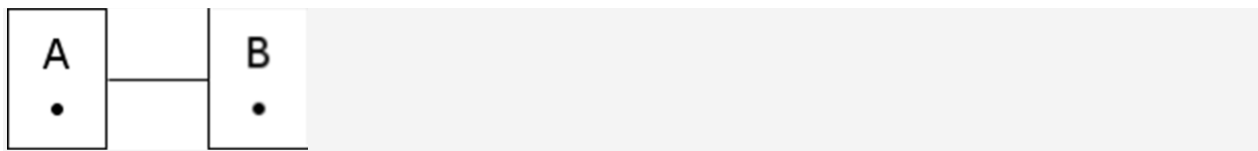

Roundabout direction is:

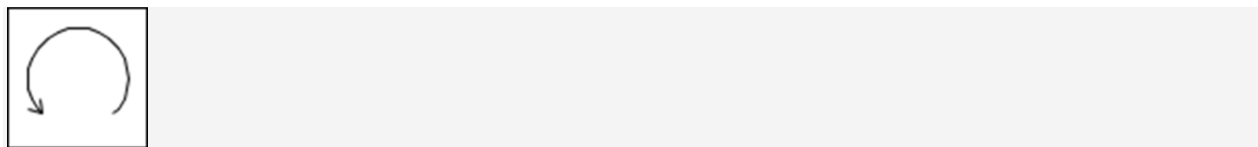

Correct route is:

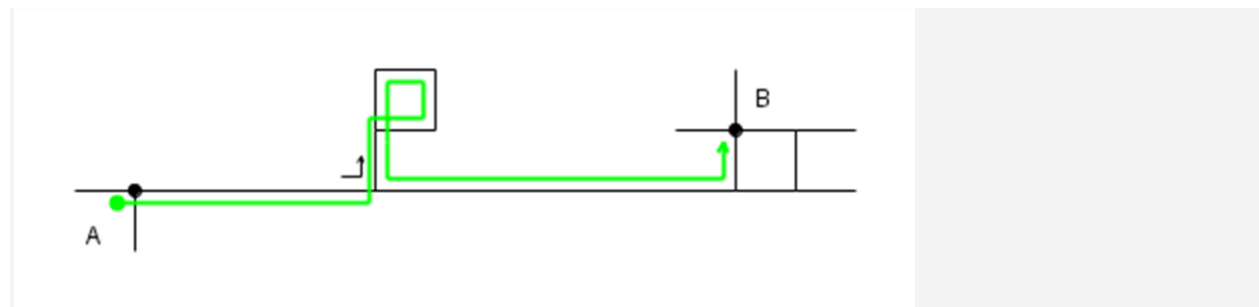

3. Example:

You should plan a route on the map from POINT A to POINT A according to the roundabout direction:

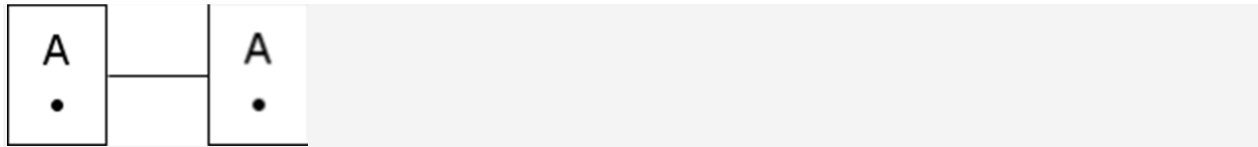

Roundabout direction is:

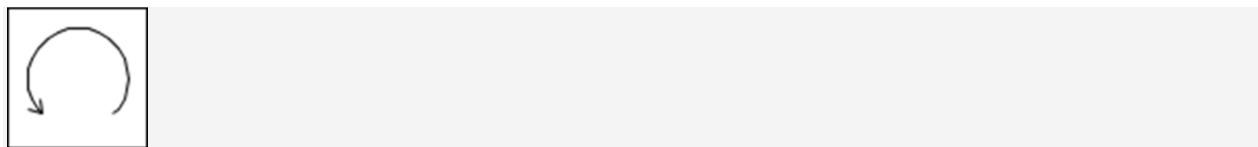

Map is:

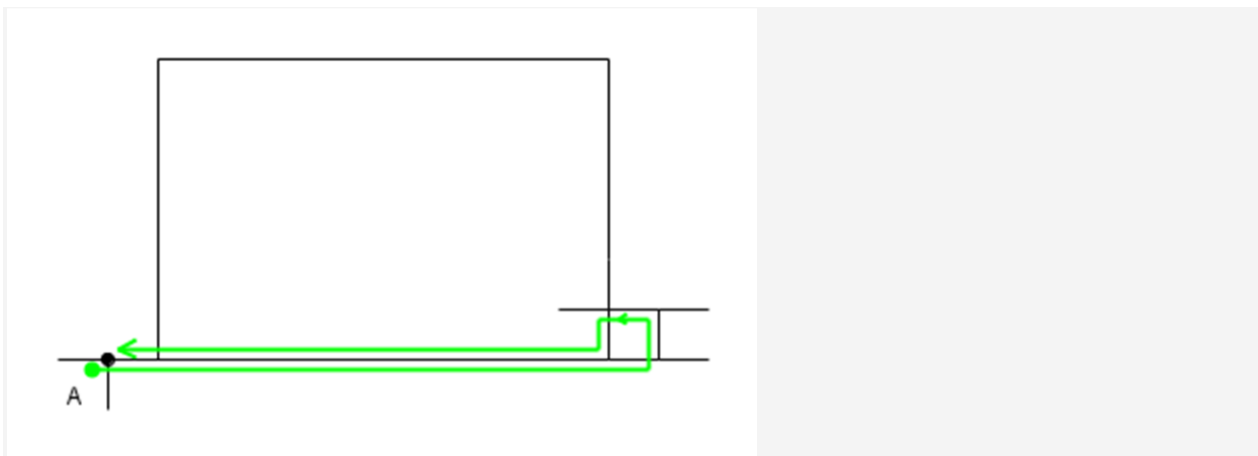

We should plan the shortest route on the map from POINT A to POINT A but we should plan according to the roundabout direction.

4a. Example:

It is a simple but longer example:

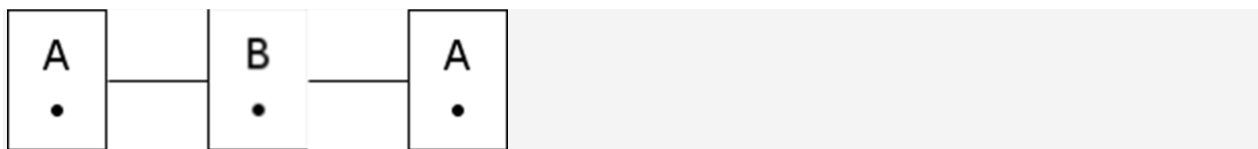

Roundabout direction is:

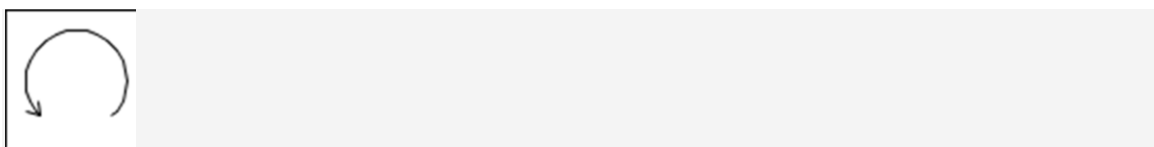

Map is:

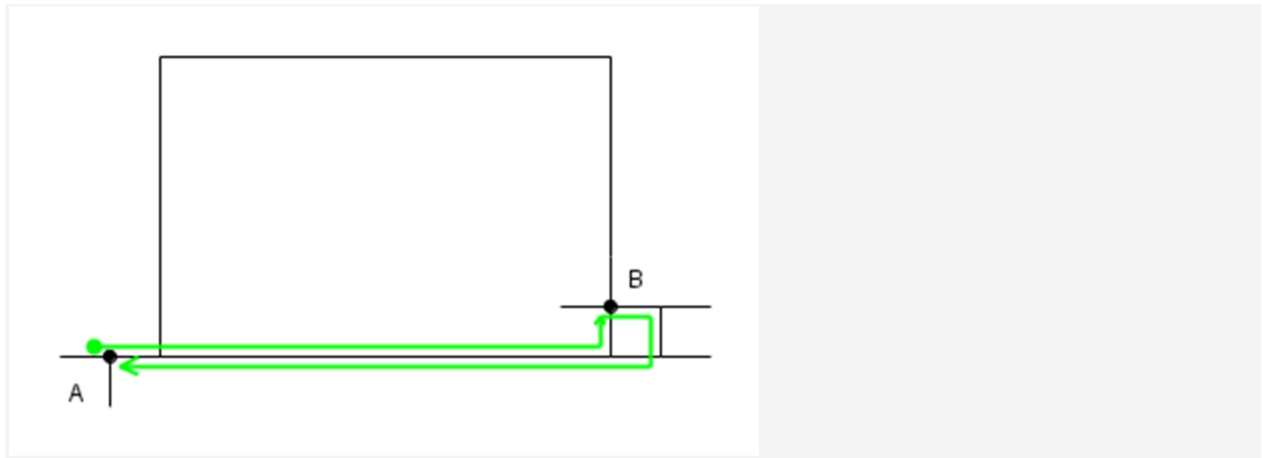

We should plan the shortest route from POINT A to POINT B and after that starts to plan a route to POINT A again. That's the reason why we don't need to pay attention to the roundabout direction. If we plan our route according to the roundabout direction then the planned route from POINT A to POINT B would be longer than in the mentioned case.

4b. Example :

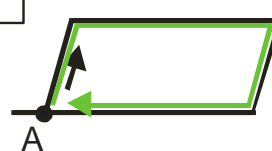
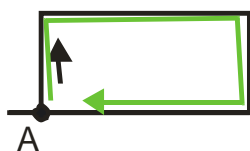
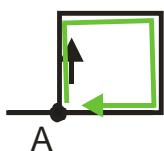
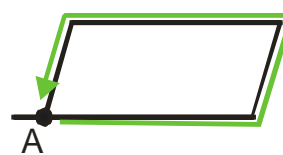
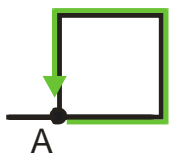
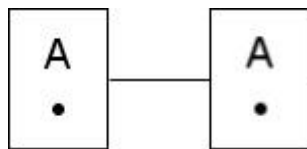

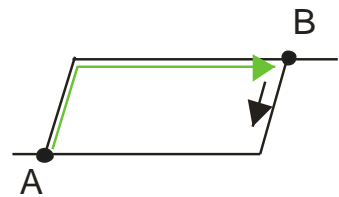
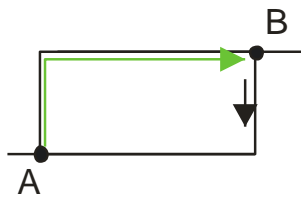
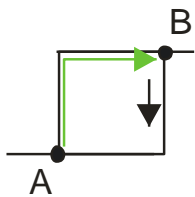
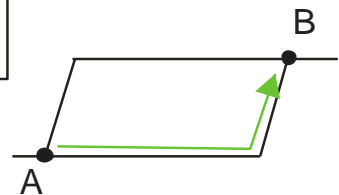
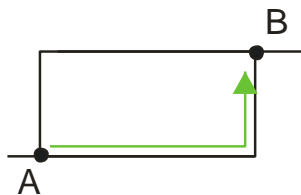
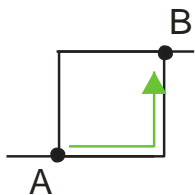
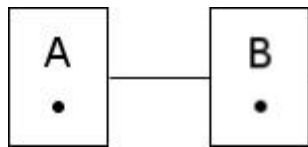

5. Example:

This is an example of arrival direction:

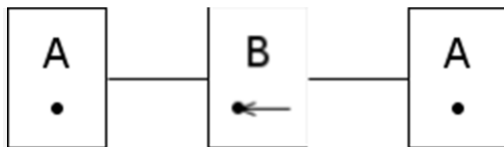

Map is:

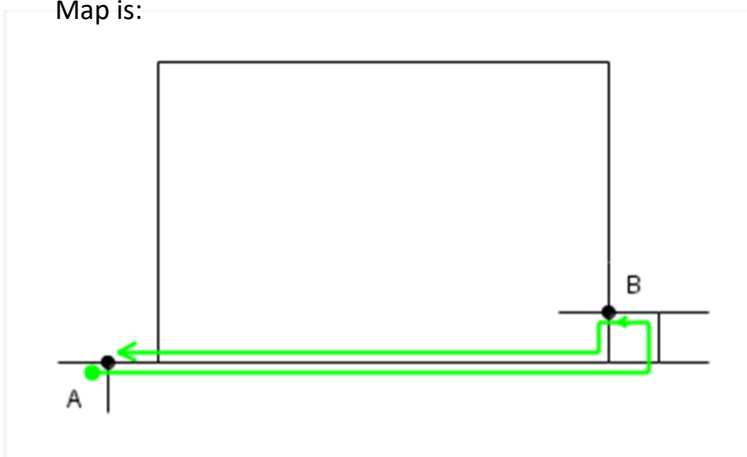

We should plan a route on the map where we can arrive to POINT B from East. After that we should plan a route on the map to POINT A.

6. Example:

This is an example of departure direction:



Map is:

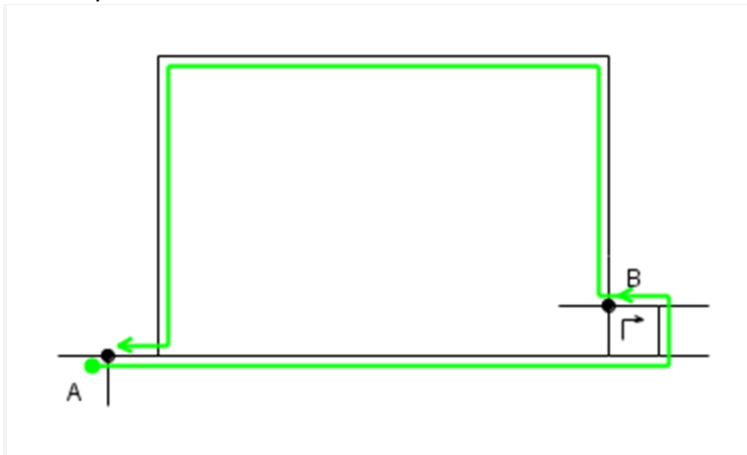

We should plan a route on the map to POINT B what should be departure towards North. When we left POINT B to North we should plan the shortest route to POINT A.

7. Example:

Arrival and departure directions together:



Map is:

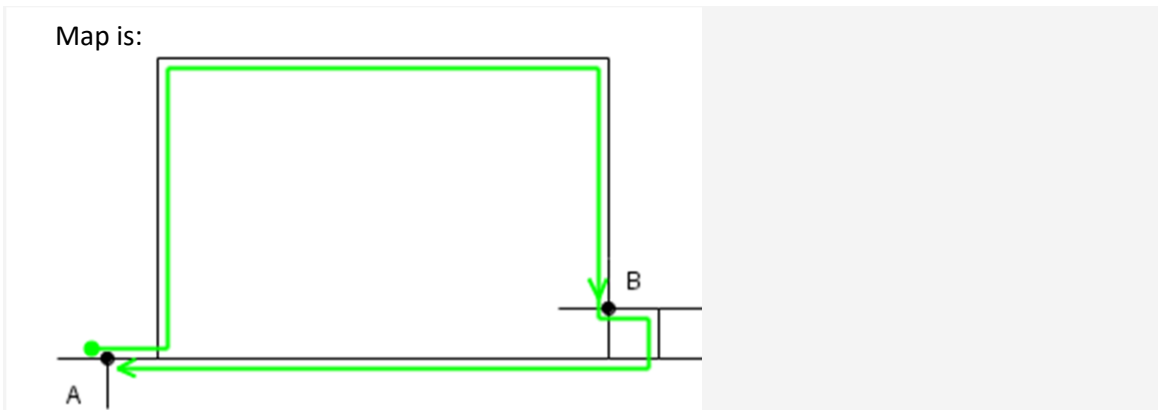

We should plan a route on the map to POINT B what fulfill the following requirements: we should arrive from North and departure to East. After that we should find the shortest route to POINT A.

8. Example:

Arrival and departure directions in separate itiner pictures:

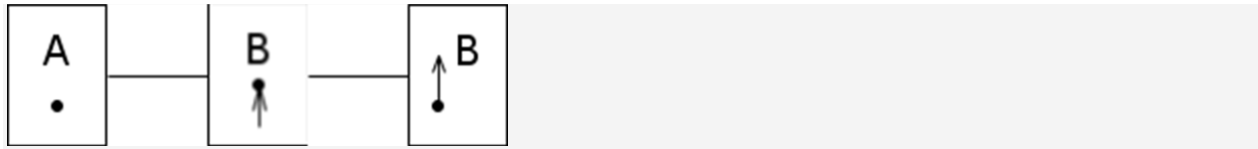

Map is:

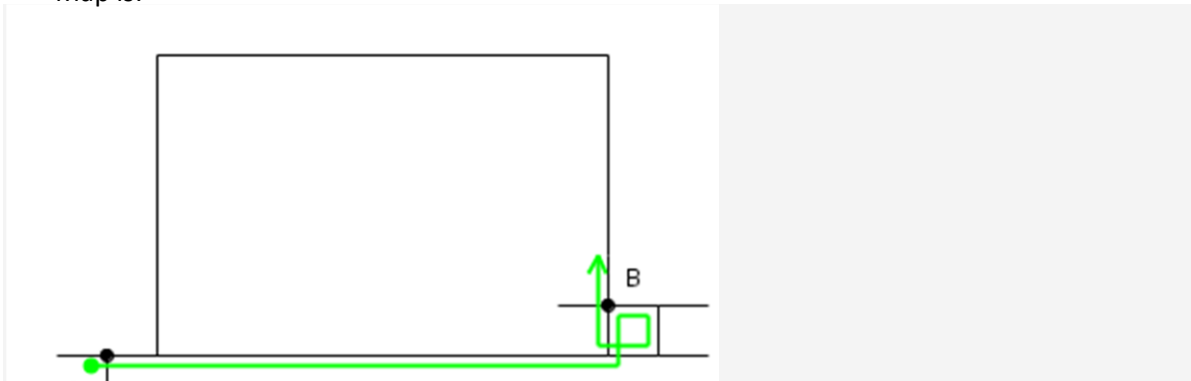

First we should arrive on the map to POINT B from South. After that we are able to leave POINT B to North but according to the itiner we should reach POINT B two times and we should travel on the map before we leave POINT B to North, so we should turn around in the square.

9. Example:

Similar than before without arrival and departure directions:

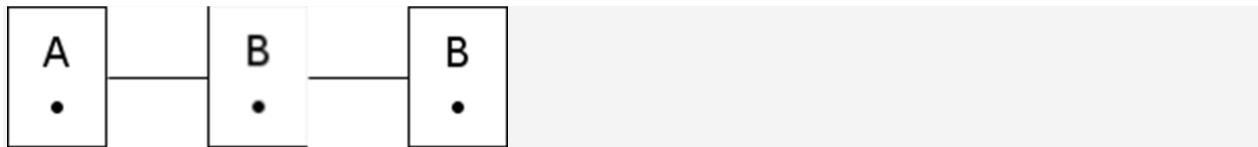

Map is:

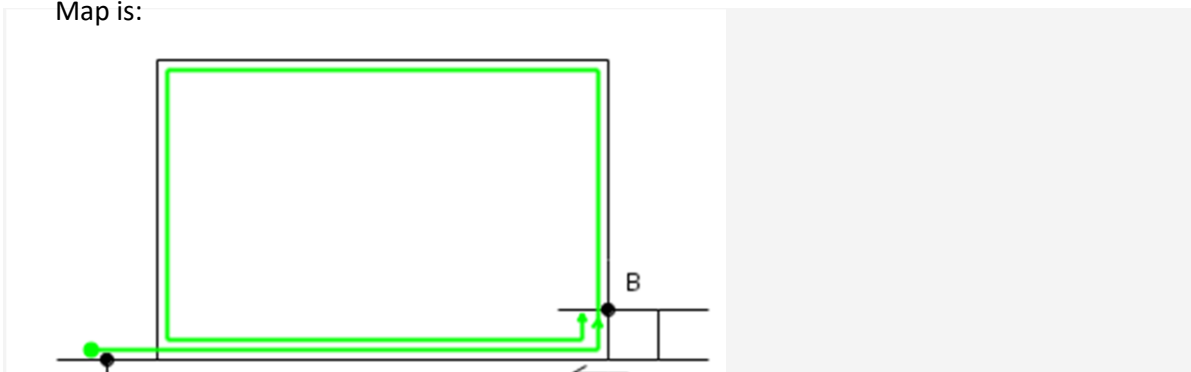

First we should reach POINT B on the shortest way after that we should find the shortest way to POINT B again.

12. Example:

We should reach POINT B on the map and departure straightforward based on real information.

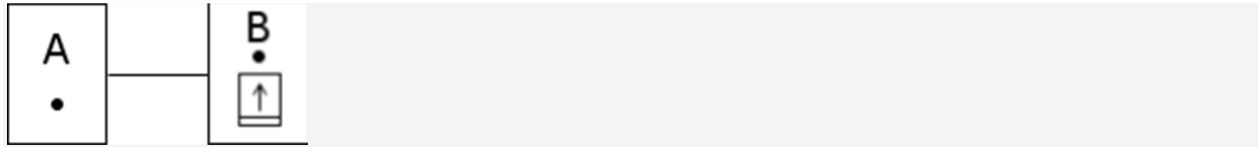

Map is:

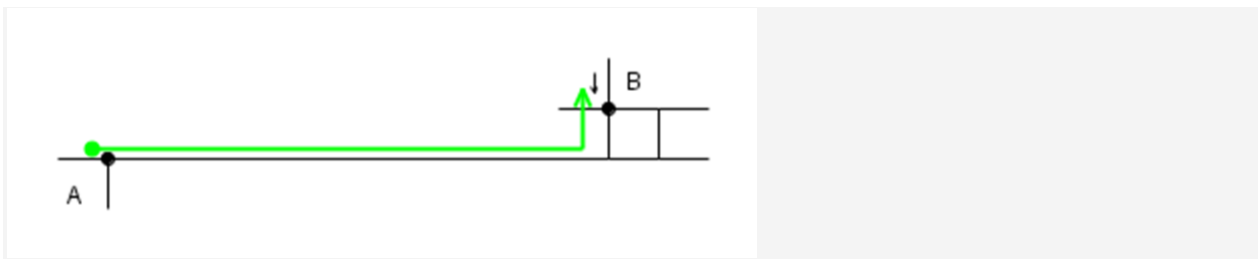

We cannot plan with real information when we plan our route on the map, so we can go to POINT B on the shortest way. When we have arrived to POINT B we will go straightforward based on real information, so we will leave that point to North based on real information, so that one way arrow on the map won't relevant for me.

16.3. Crosses and turns – navigation on the map from map point to map point

1. Example:

Itiner:

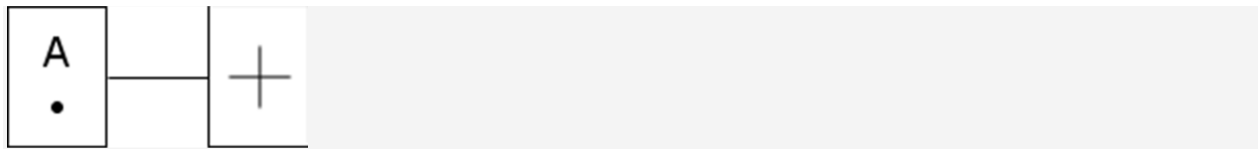

Map is:

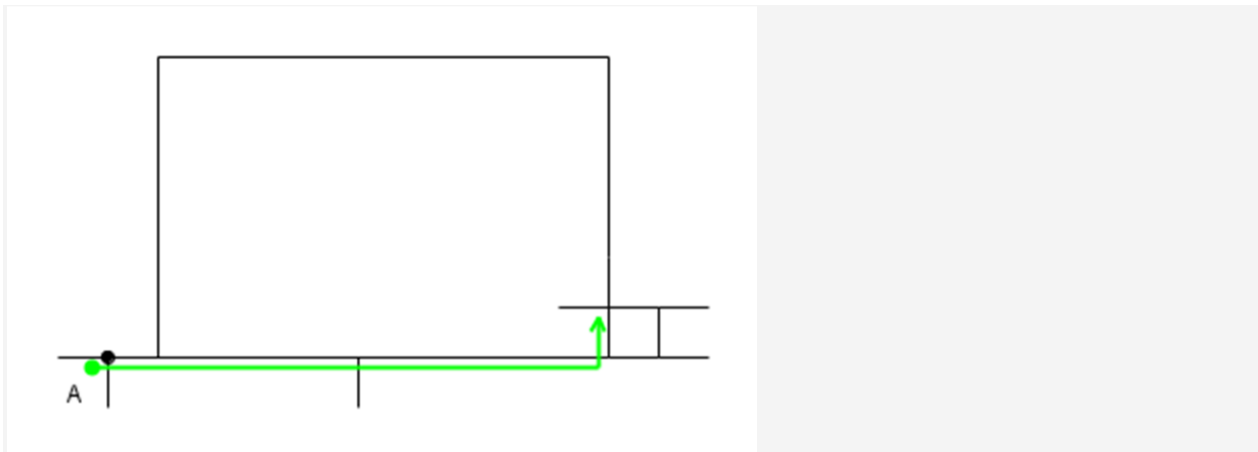

We should find the nearest full-cross which has the same type than indicated on the picture (consist of North-South and East-West crosses).

2. Example:

Itiner:

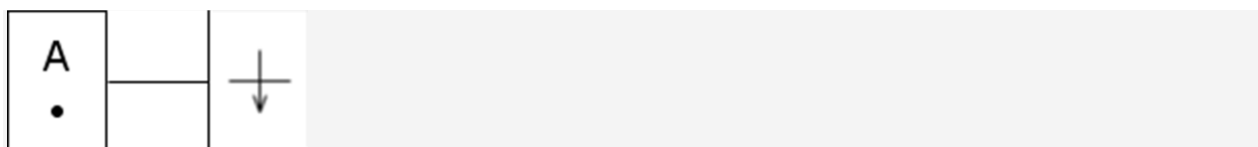

Map is:

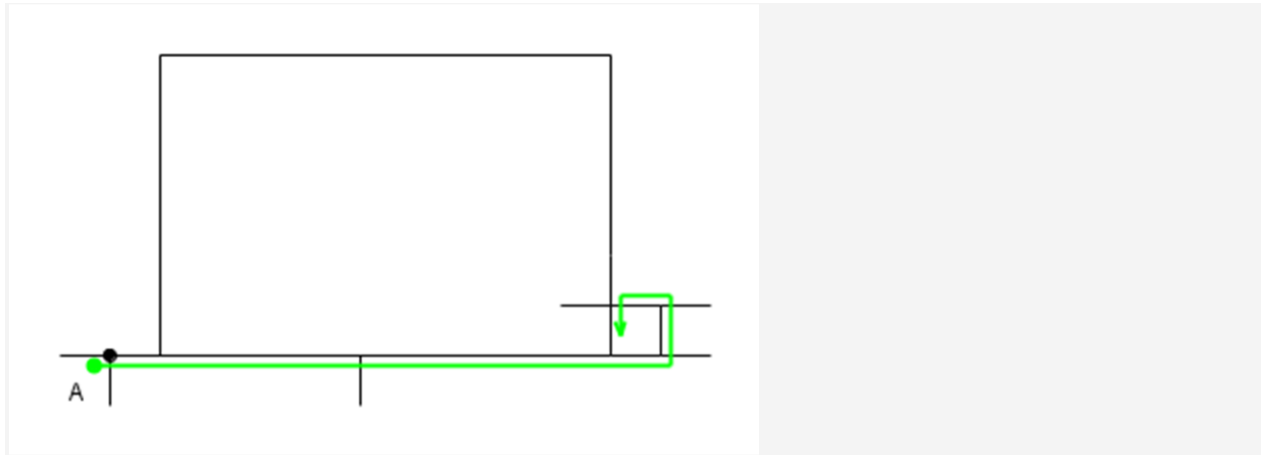

You should arrive to the full-cross on the map from that direction where you will be able to leave that to South.

3. Example:

Itiner:

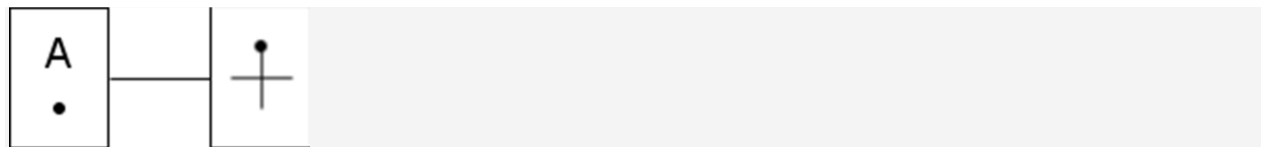

Map is:

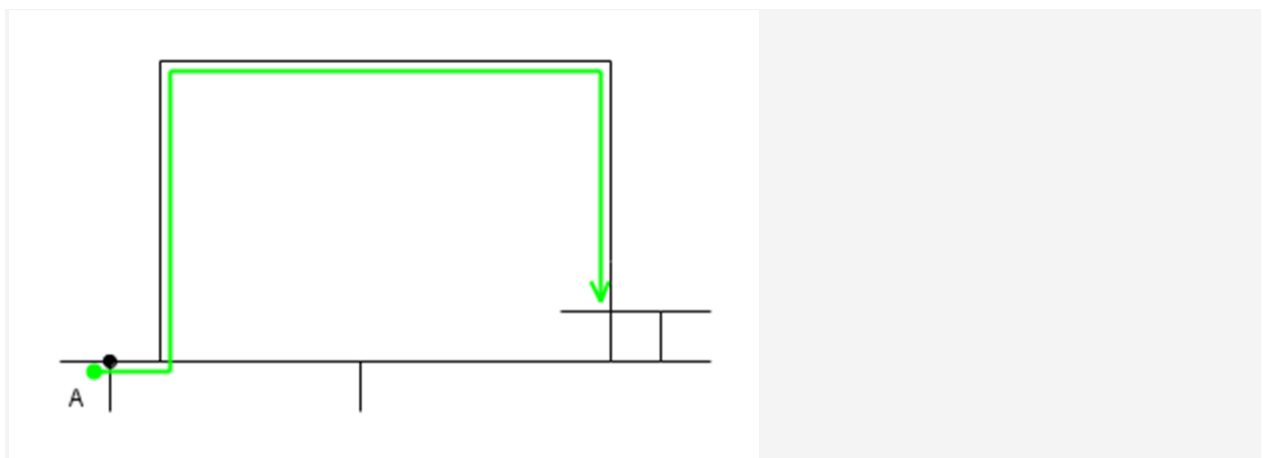

You should arrive from North to the full-cross on the map

4. Example:

Itiner:

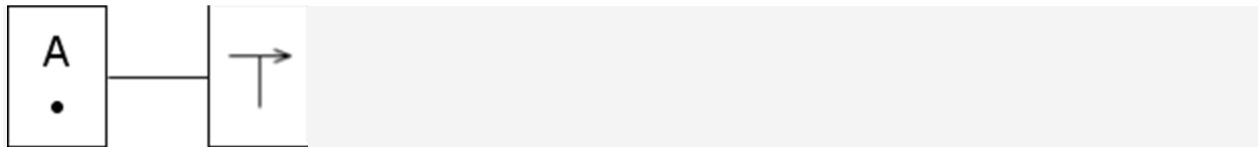

Map is:

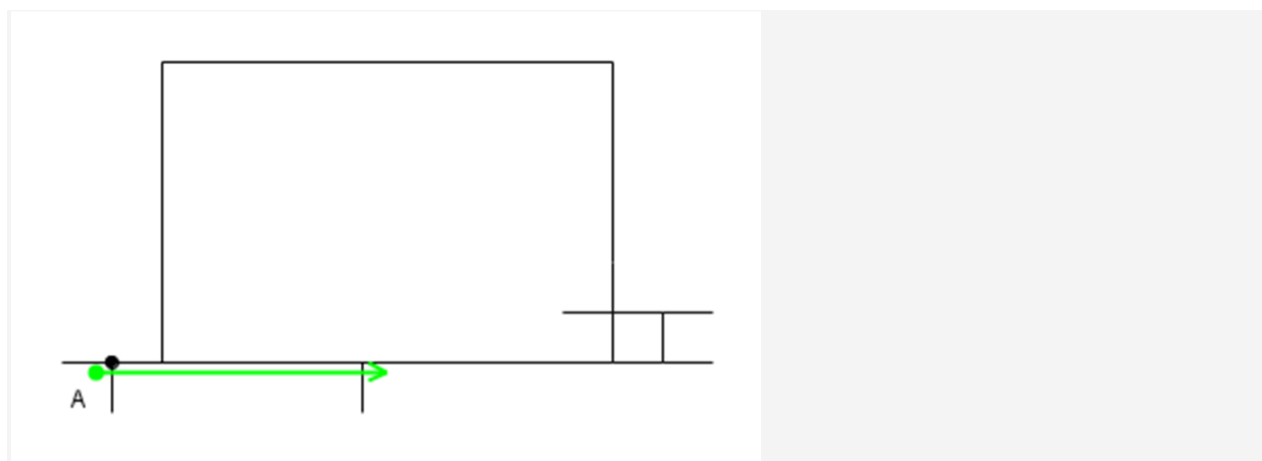

You should find the nearest T-cross on the map.

5. Example:

Itiner:

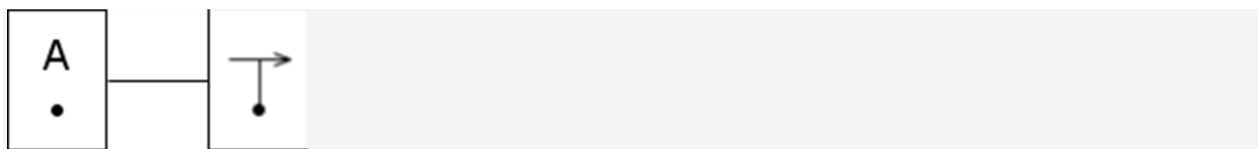

Map is:

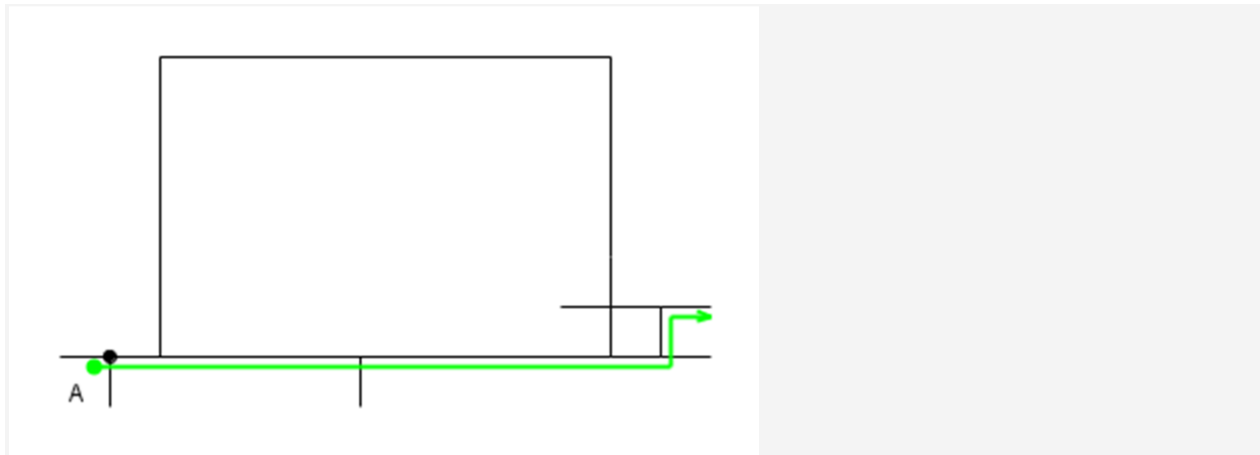

You should find the nearest T-cross on the map where it has streets towards East, West and South and you are able to reach that cross from South. When you are there you should leave that cross towards East.

6. Example:

Itiner:

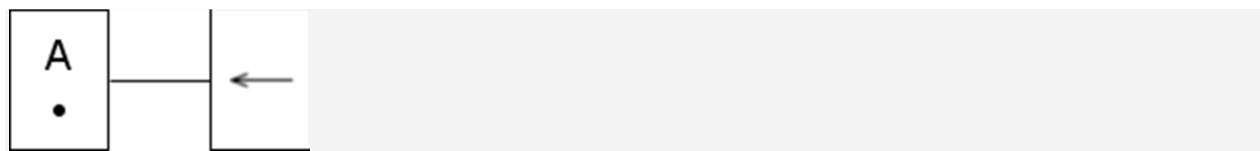

Map is:

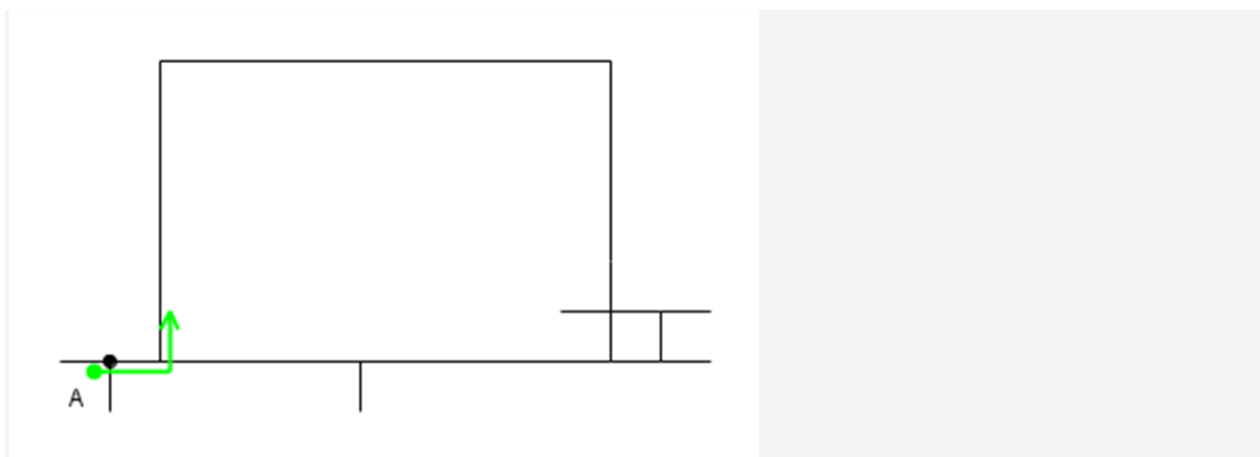

You should turn left at the nearest cross on the map where it is possible.

7. Example:

Itiner:

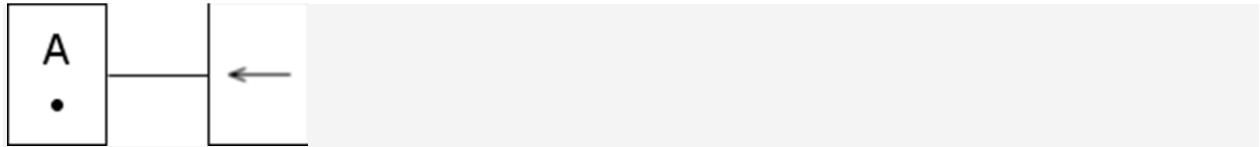

Map is:

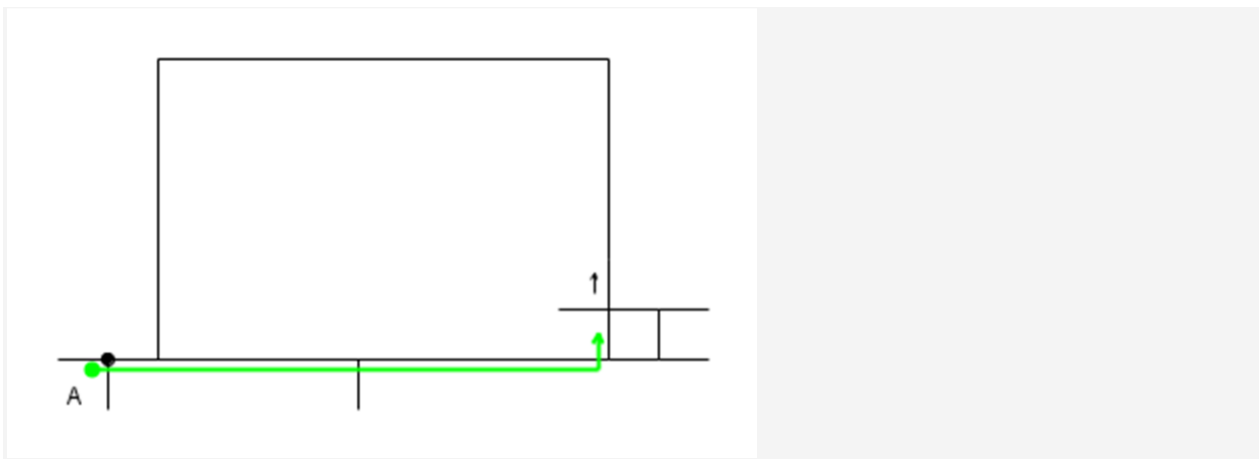

The first street on the map is one way street from the other side, so the first possibility where we can turn left is the cross below the full-cross.

8. Example:

Itiner:

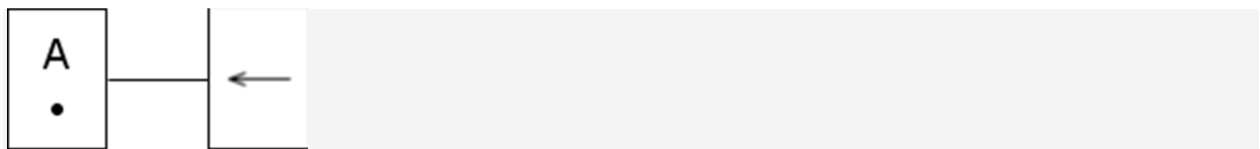

Map is:

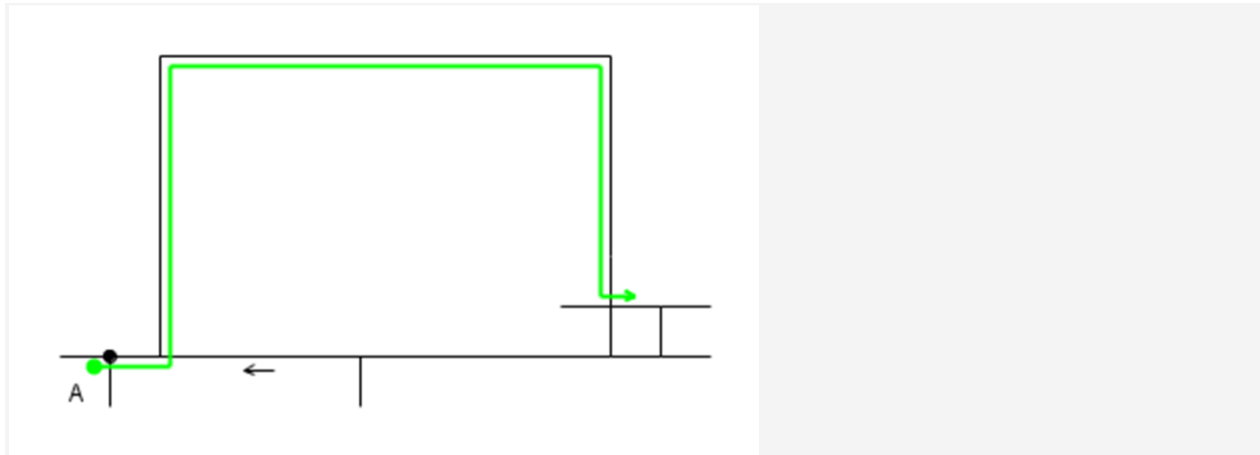

You cannot go straightforward at the first cross because of one way arrow, so that is not a real cross (because you cannot go other way than left), so you can turn left at the full-cross as nearest.

9. Example:

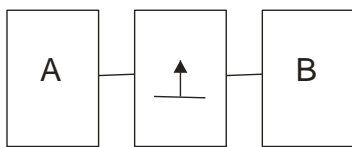

MAP :

Reality :

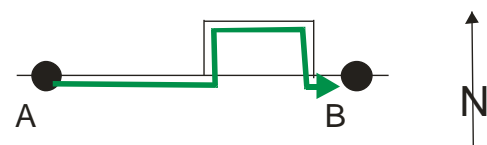
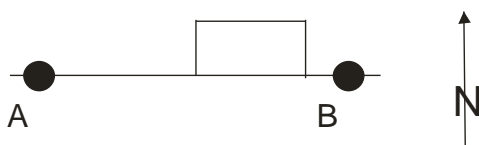

or

MAP :

Reality :

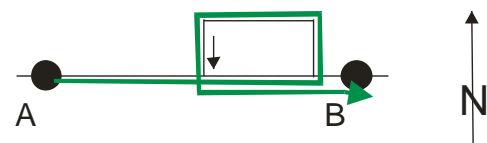
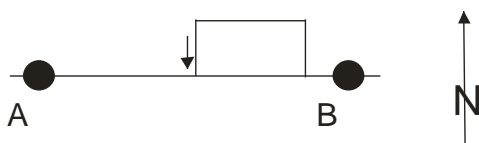

If the itiner just said that you should map turn left then you can turn left at the nearest map cross where it's possible independently of cross type and after turn left must exist next a map solution.

10. Example:

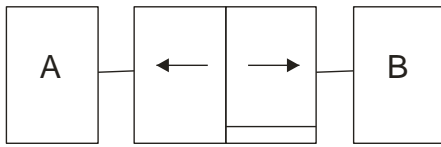

MAP :

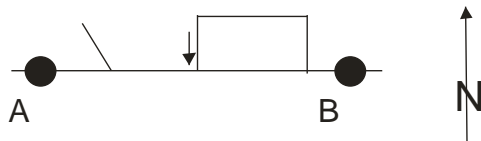

no map road

Reality :

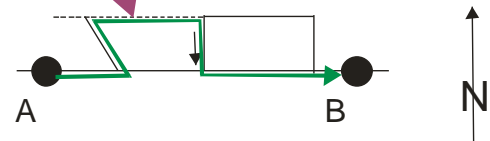

or

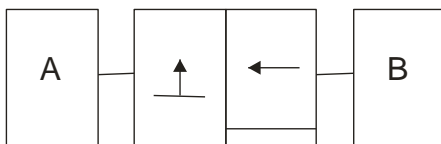

MAP :

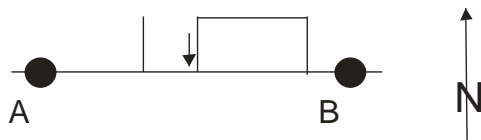

turn back checkpoint

Reality :

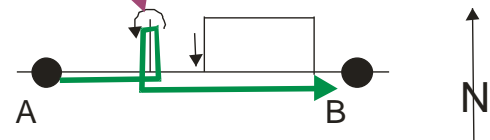

or

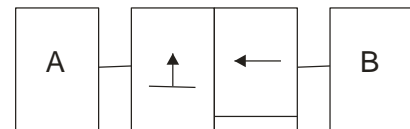

MAP :

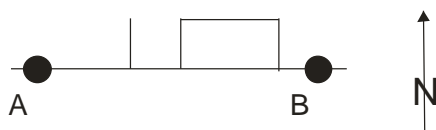

XX checkpoint = new constans - $\boxed{XX} = \ominus = \bigcirc$

Reality :

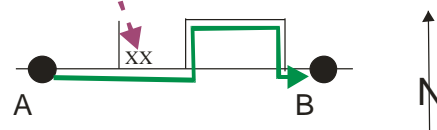

If the itiner just said that you should map turn left then you can turn left at the nearest map cross where it's possible independently of cross type and after turn left you can continue real to next real window.

16.4. Objects on the map and other signs – navigation on the map from map point to map point

1a. Example:

Itiner :

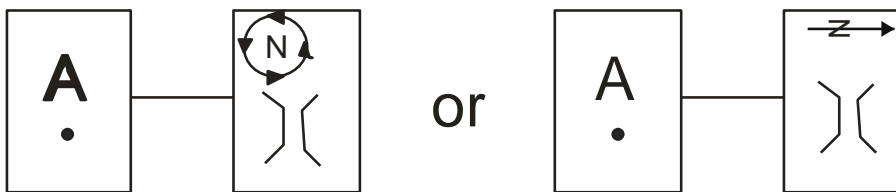

Map is :

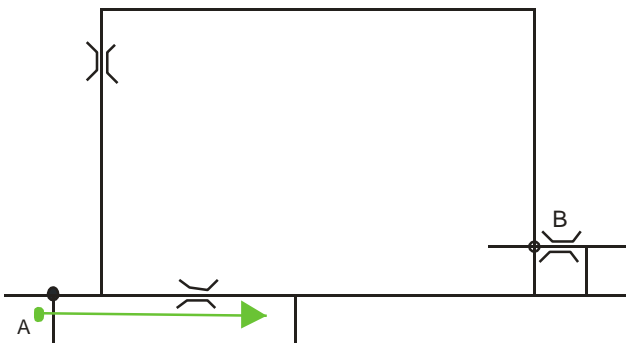

In case of map objects you should also find the nearest one but but these map's bridges are not orientated to North

1b. Example:

Itiner :

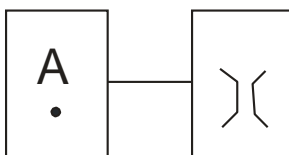

Map is :

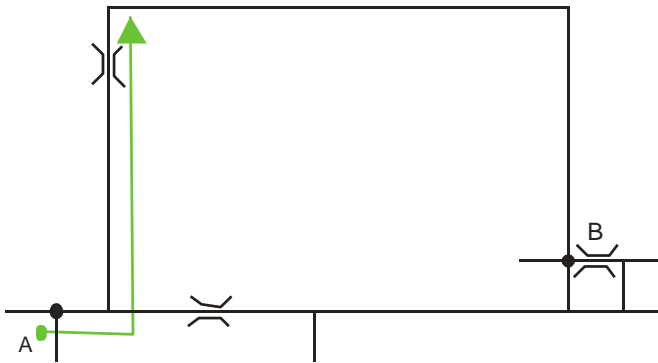

In case of map objects you should also find the nearest one but these map's bridges are orientated to North

2. Example:

Itiner:

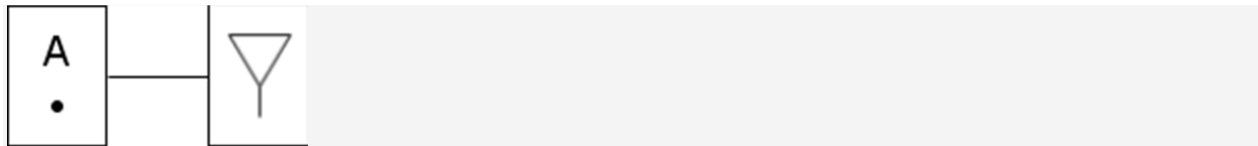

Map is:

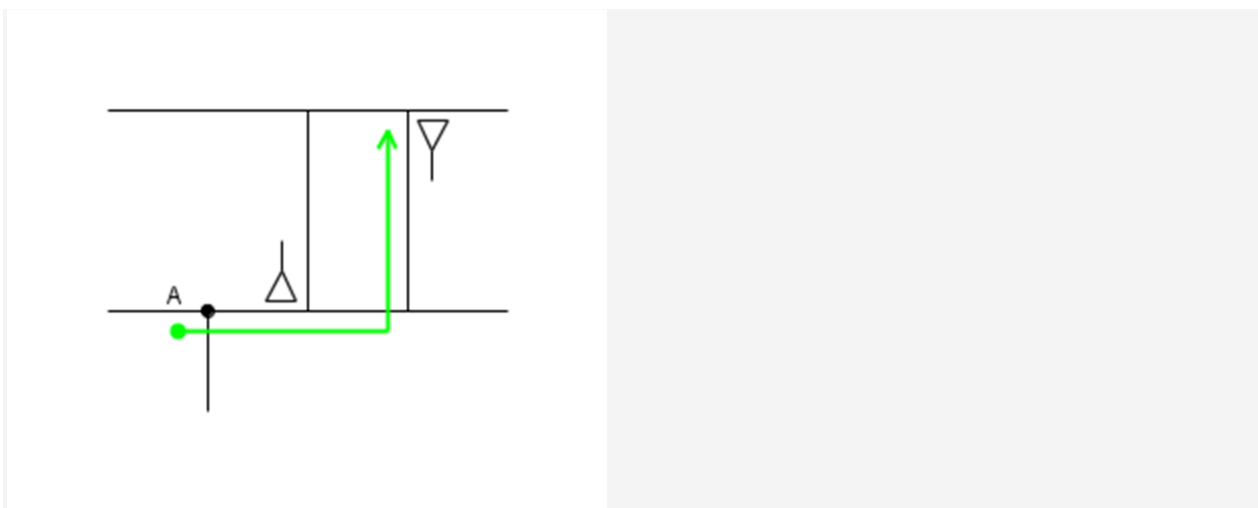

If you should find a certain road sign because of the itiner then you should pass that road sign according to standard traffic rules (road sign should be passed at the right side of the car) and you should arrive from the leg of the road sign.

3. Example:

Itiner:

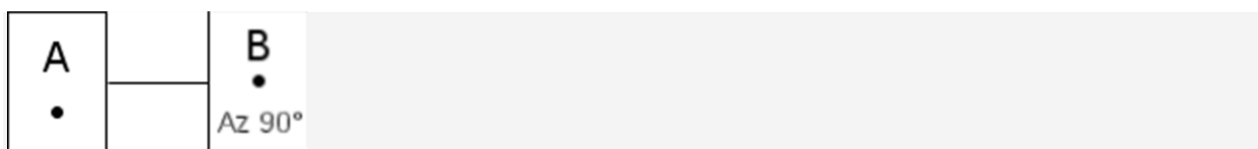

Map is :

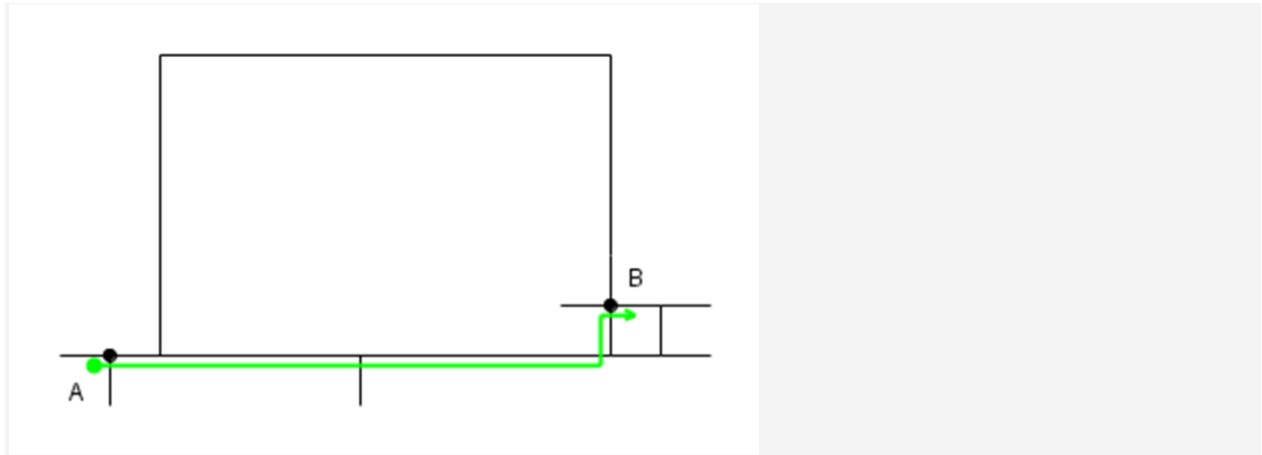

“Az XX° ” mark means Azimut it means the difference from North in degrees. In the example you should arrive to POINT B from a direction where you can leave that POINT to 90° from the North (it is East).

4. Example:

Itiner:



Map is:

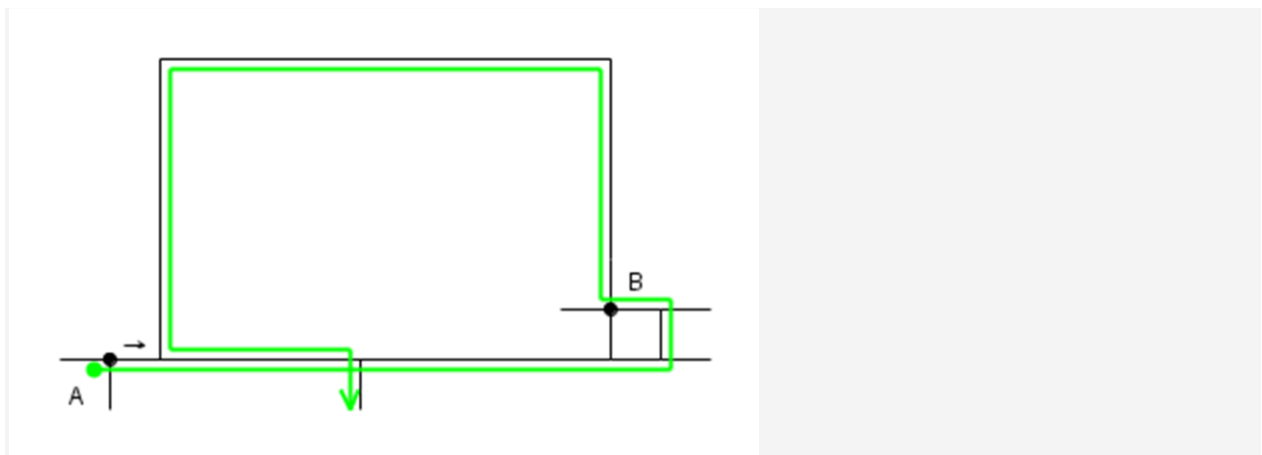

This type of itiner called “straight” itiner because the route is defined along with the central line. You should leave the marked streets according to the itiner picture, so you should keep in mind the type side of the streets (and sometimes the direction could be help as well but it’s not mandatory) but the distances between streets are not relevant. Cross means only that cross where you have possibility to choose among directions.

5. Example:

Usage of different maps:

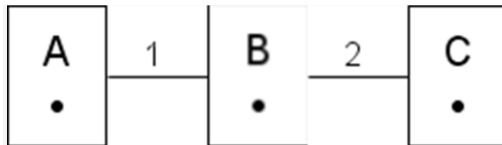

The number above the line between itiner pictures means that you should use that certain map to plan your route.

Map 1:

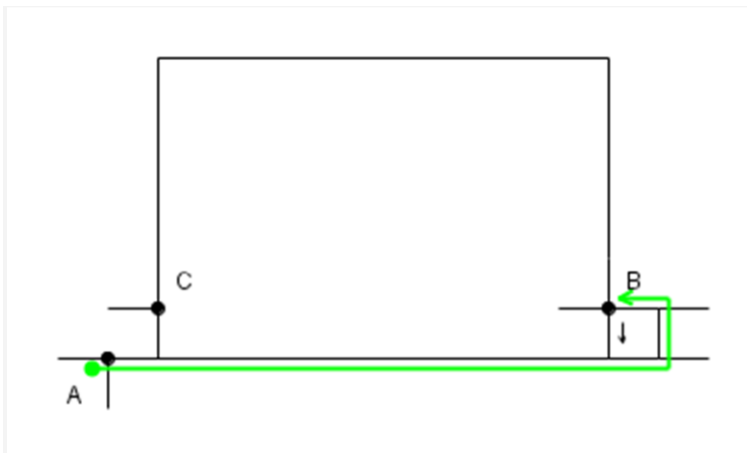

Map 2:

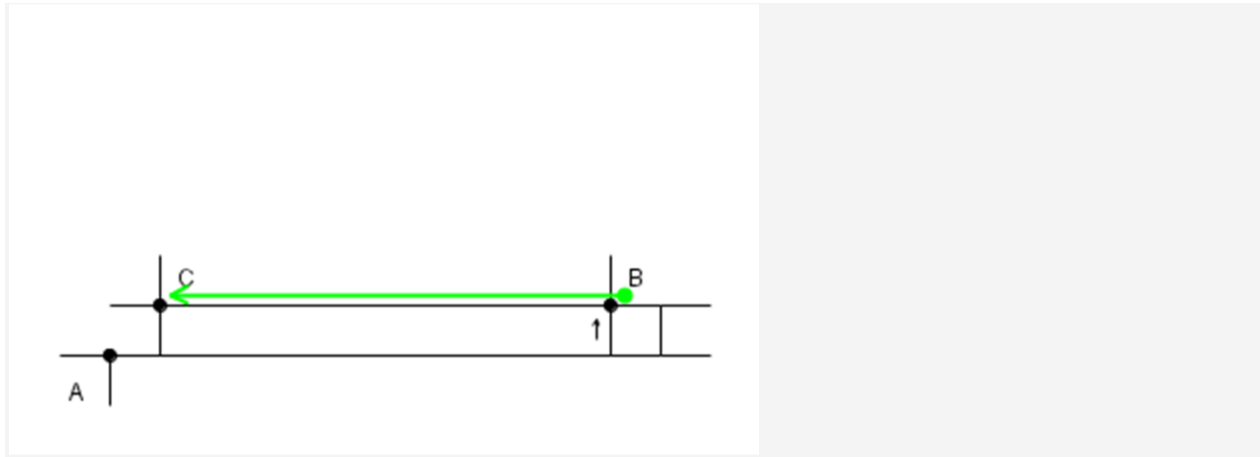

When we are planning a route on a certain map we should bypass all the information on other maps.

16.5. Re-planning of the route – navigation on the map from map point to map point

You can find examples here where you should re-plan your route on map because of real information. Itiner is the same for first six examples:

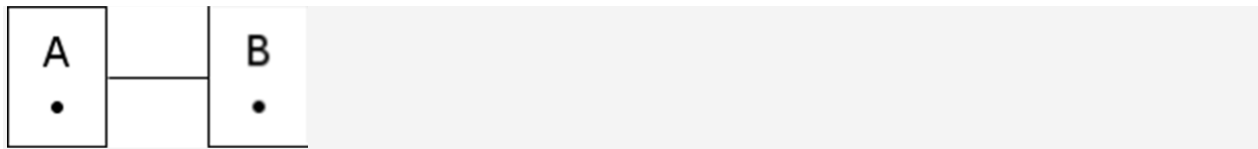

Map is also the same for first six examples:

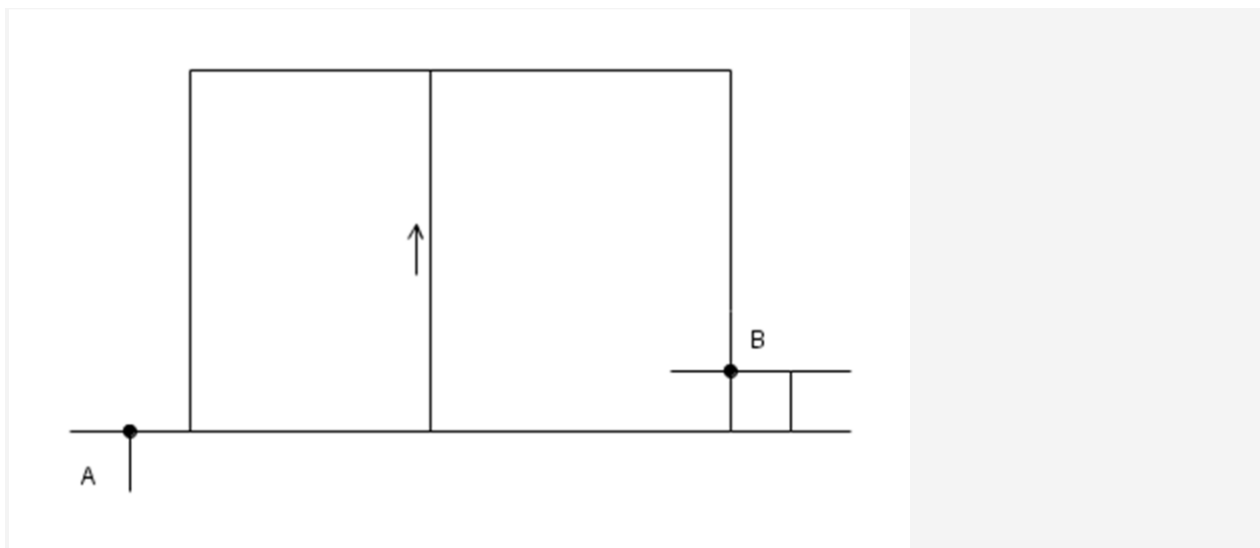

Green line means the correct route, red line means that route which planned originally.

1. Example:

Reality:

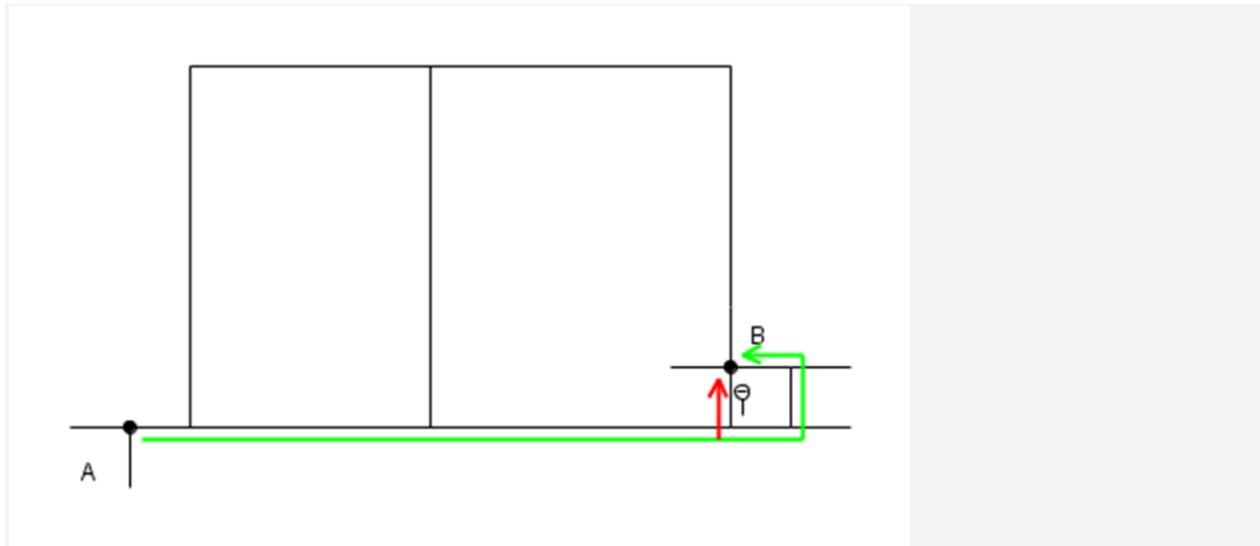

You cannot turn left where you have planned because of “no entry” road sign. The new route is straightforward from that point and arrives to POINT B from East.

2. Example:

Reality:

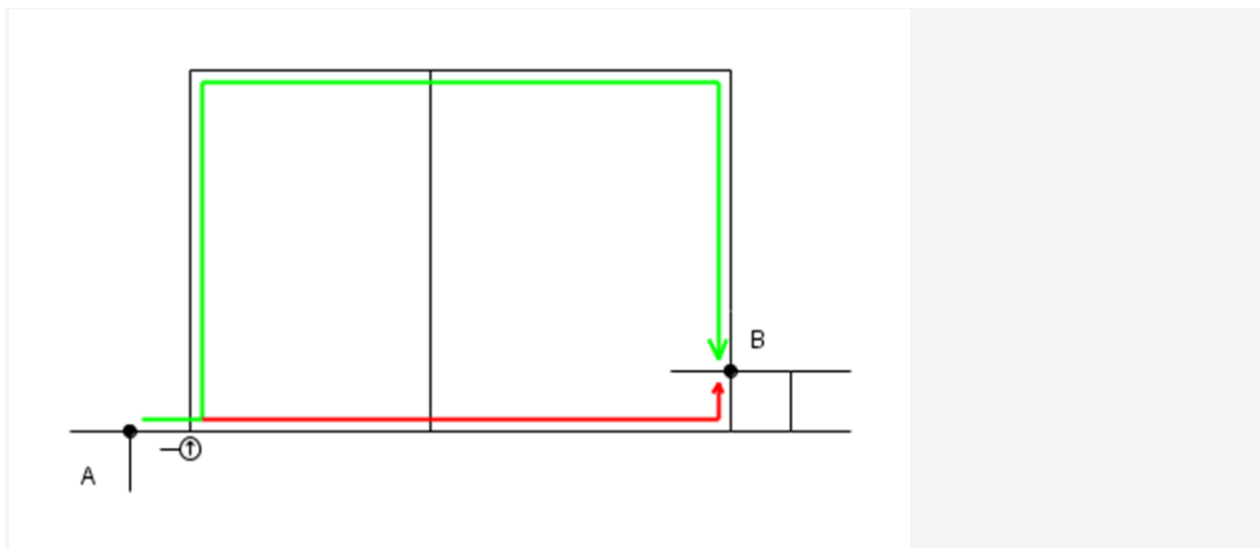

You should turn left because of “go this way - left” road sign. The new route is simple after that.

3. Example:

Reality:

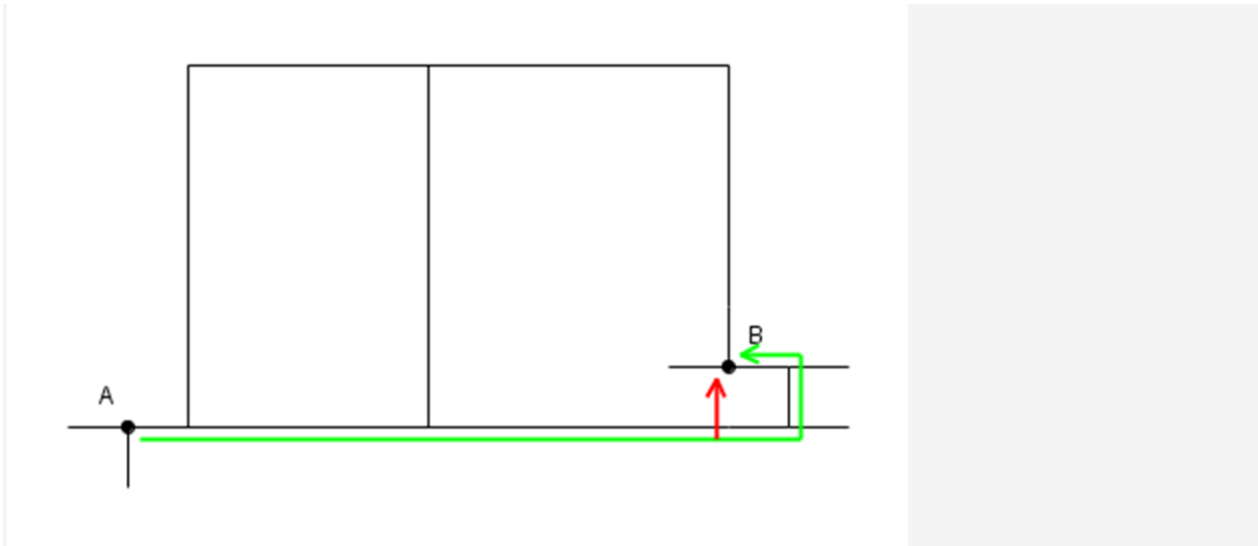

That street marked on the map is not available in the real world. It is the same situation than we would have “no entry” sign on that street.

4. Example:

Reality:

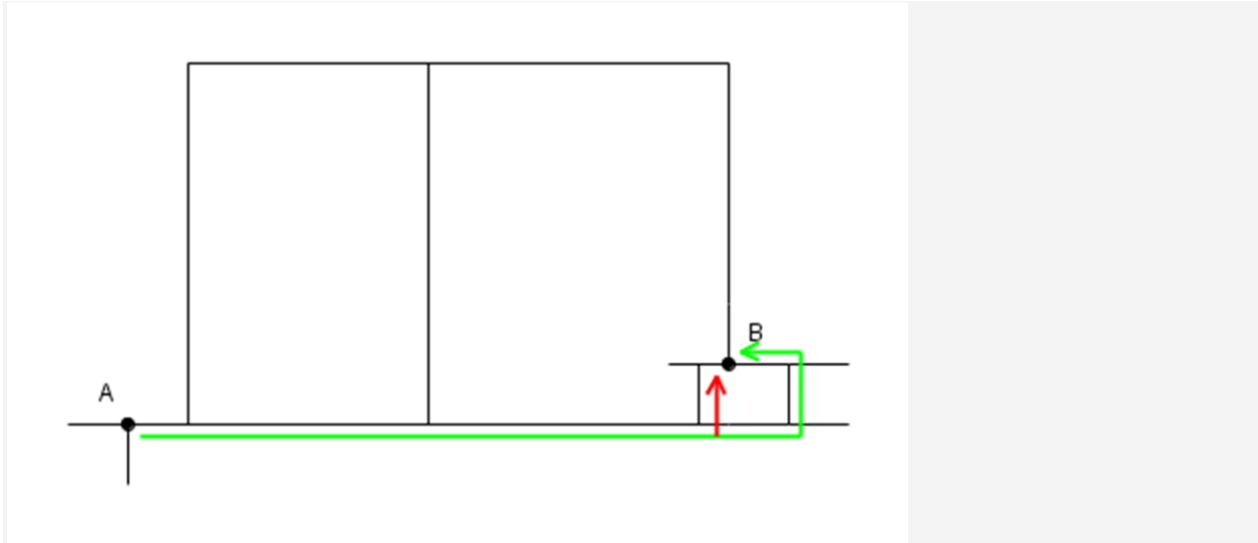

We don't have street in the real world as in the previous example. There is other street in the real world but based on the 5mm rule it is not a measurement error this should be handled as a street which is not marked on the map.

5. Example:

Reality:

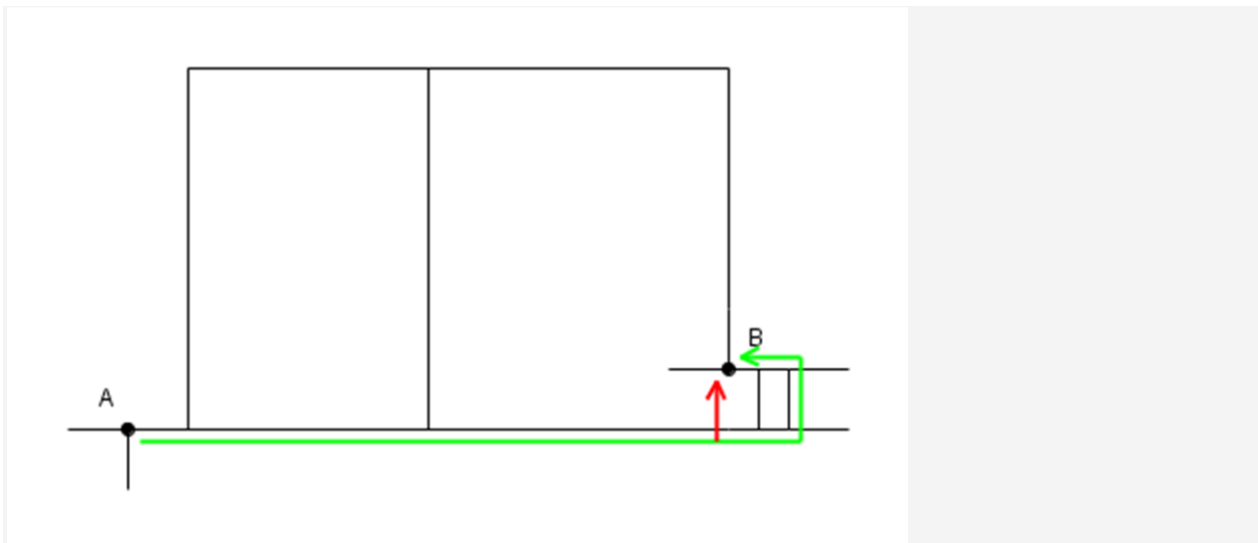

The situation is the same as before except you have that real street West from the point but if you measure that to the map the difference will be more than 5mm.

6. Example:

Reality:

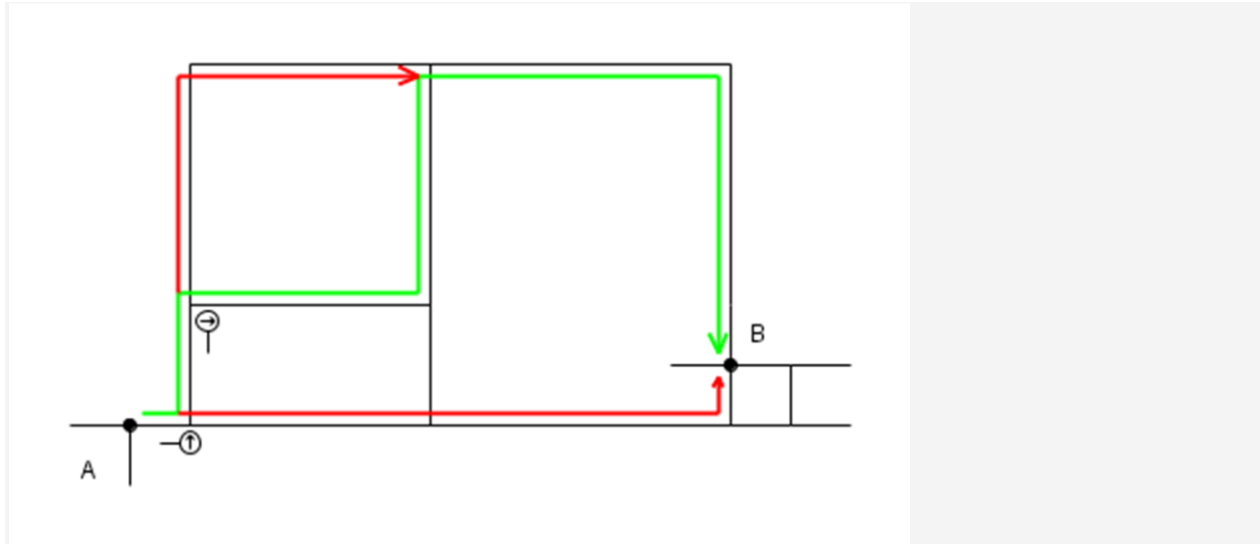

It is a more complex example: you should re-plan your route two times. During second interrupt we will leave the map and we should travel according to the navigation rules based on real information until we will be on the map again. When we will be on the map again we will be on a one way street, that's the reason why we continue our way towards North.

7. Example:

An example with new itiner and new map:

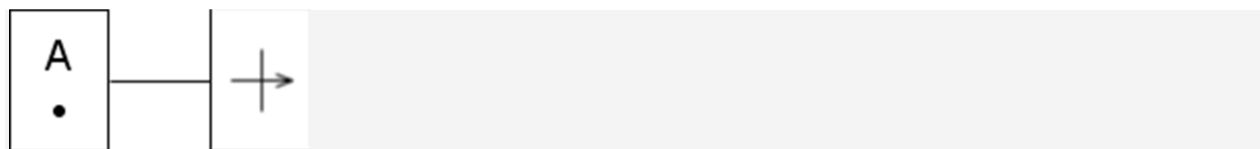

Map:

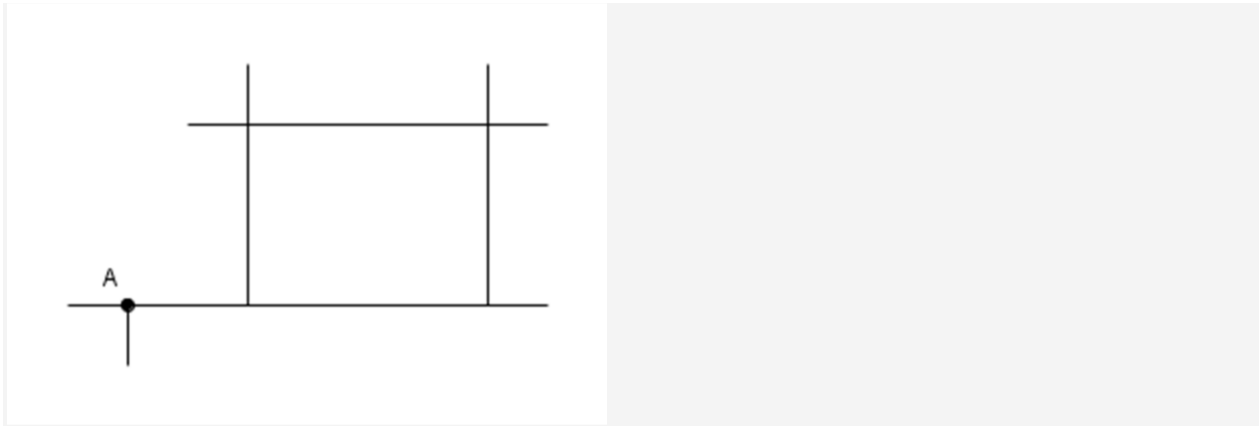

Reality:

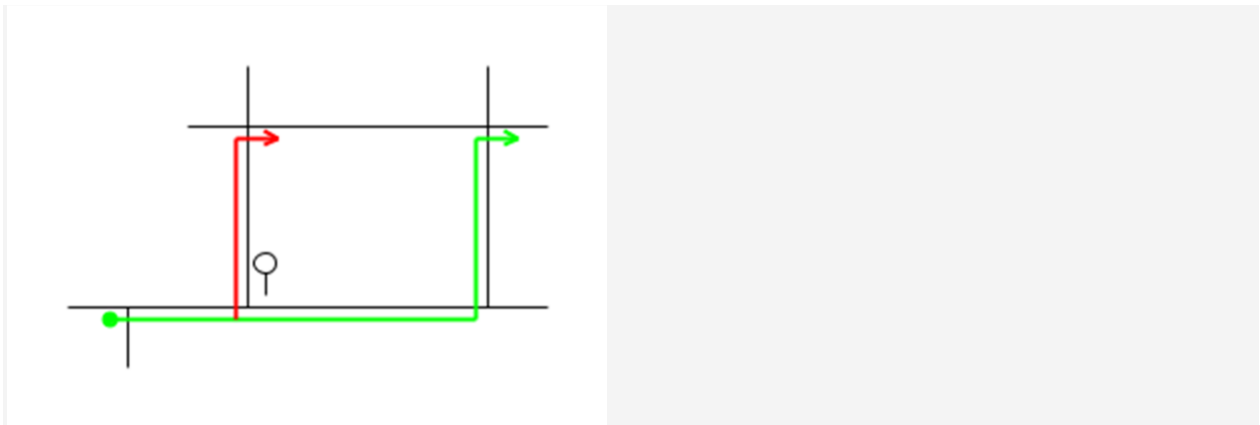

When we re-plan our route because of “no entry” sign we should find the nearest full-cross which will be different from that one what we have planned originally.

8. Example:

An example when we don't need to re-plan our route:

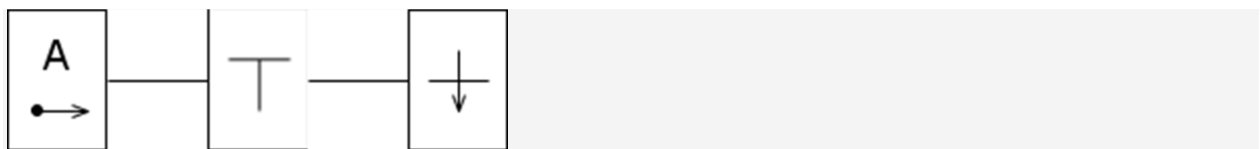

Map:



Reality:

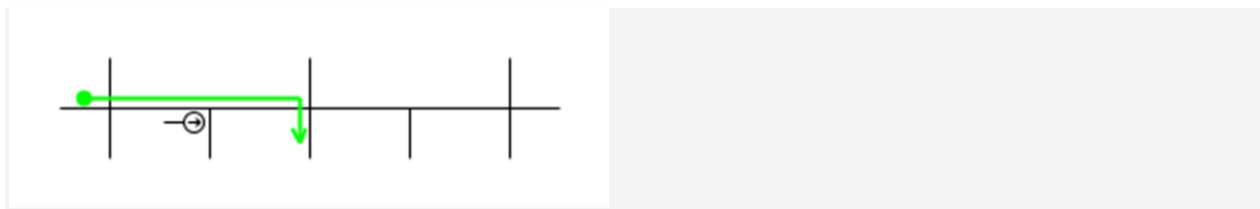

After the first cross from POINT A we can move only to East, luckily it is the same route what we have already planned, so we can keep our plan because second cross is match with second itiner picture.

16.6. Basics – navigation from real point to real point based on real information

1. Example:

Itiner:

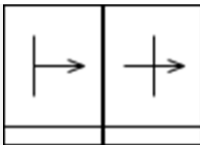

Reality:

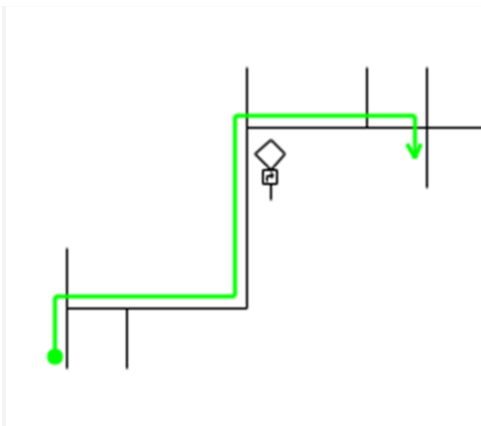

After “turn right” we can travel according to the navigation rules based on real information until we will be able to turn right at a full-cross.

2. Example:

Itiner:

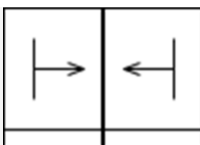

Reality:

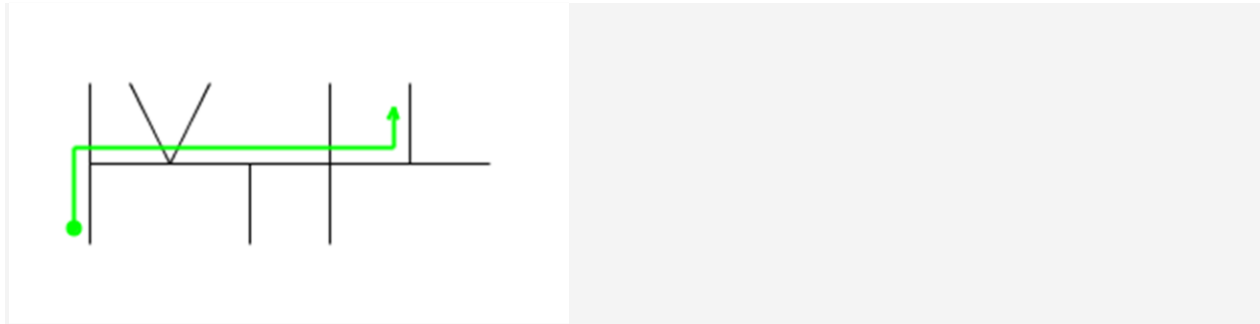

After “turn right” we can travel according to the navigation rules based on real information until we will find that certain cross type.

3. Example:

Itiner:

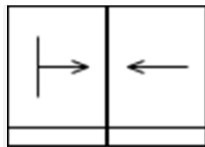

Reality:

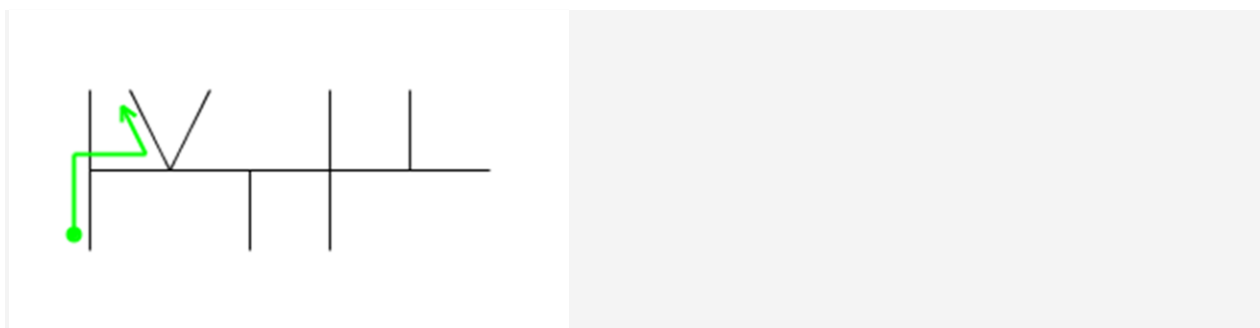

After “turn right” we can travel according to the navigation rules based on real information until we can turn left at the first possibility.

6. Example:

Itiner:

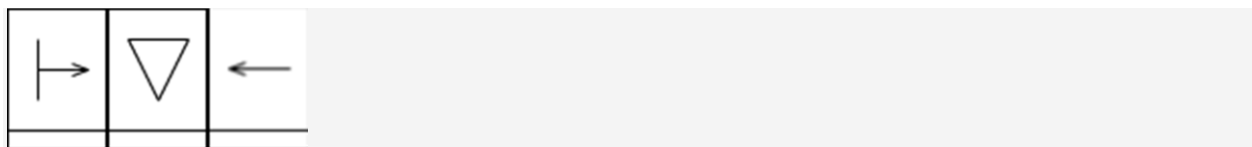

Reality:

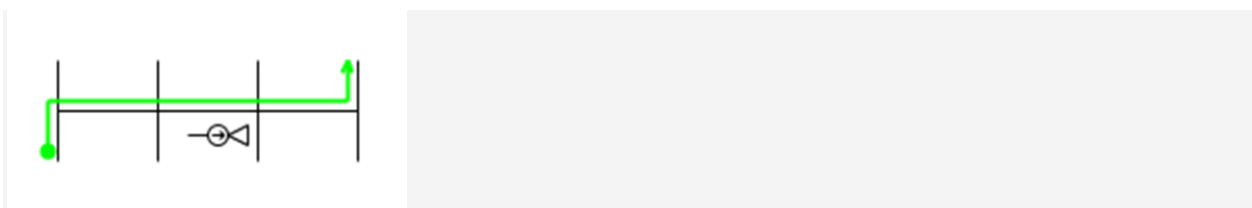

We would like to emphasize that we should turn left after the “priority sign” road sign where we have cross with at least two choices.

7. Example:

When we should turn left at certain road sign then the short version of itiner pictures described in 5. Example is:

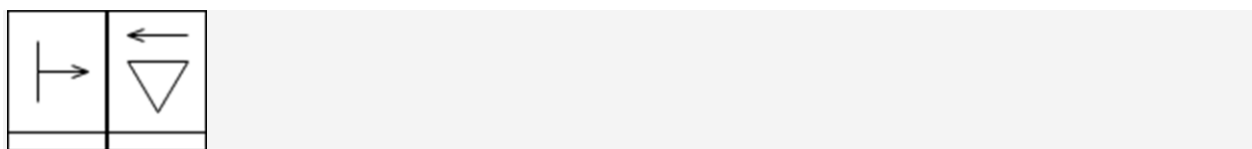

Reality:



8. Example:

We have different sign for certain road sign or for road signs in general.



Reality:

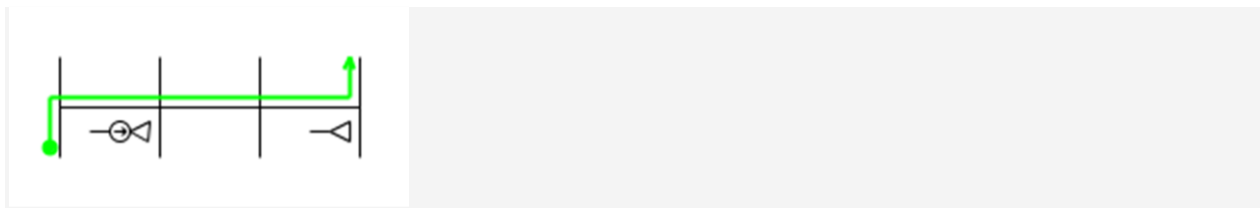

When we have driven until a certain road sign then it is marked with leg on the itiner and you should find exactly the same road sign what we have on the itiner (without complementary sign). If you have road sign without leg in the itiner then you should find a road sign which valid for you but should have complementary sign as well.

9. Example:

When only turning arrow provided you should choose the first available version at the first suitable cross. (E.g. If you have more than one crosses at the dedicated direction you should choose the "most" one.)



Reality:

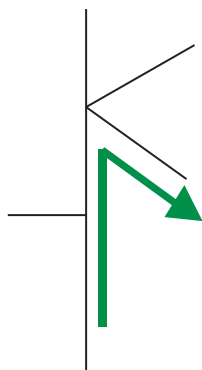

16.7. Others – navigation from real point to real point based on real information

1. Example:

Itiner:

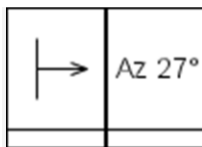

Reality:

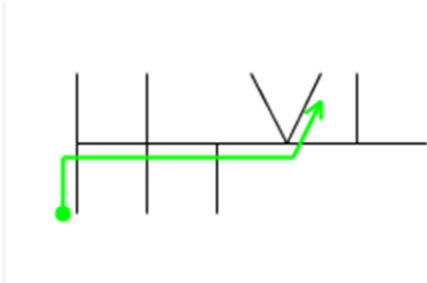

After “turn right” we can travel according to the navigation rules based on real information until we can turn at the indicated direction at a cross. Number in the itiner picture means the difference from North in degrees.

2. Example:

Itiner:

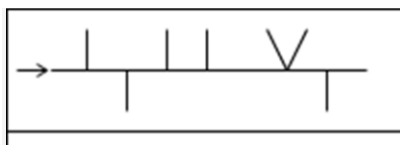

4. Example:

Itiner:

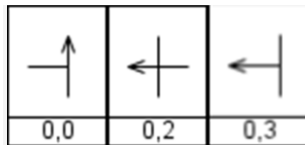

Reality:



In this example the numbers are representing the distance from the first itiner picture not between the itiner pictures.

5. Example – real line itinerar :

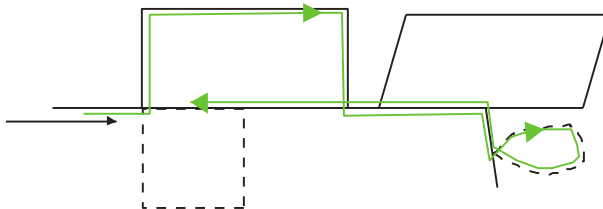

Real Line Itinerary - in night - must be distinguished asphalt roads from non-asphalt roads :

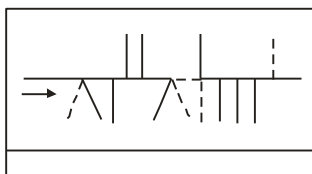

only

Real Line Itinerary - in day - no must be distinguished asphalt roads from non-asphalt road:

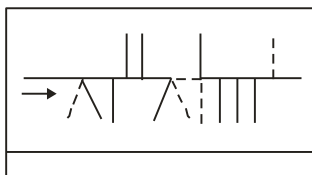

or

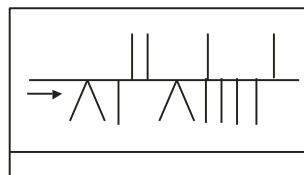

6. Example – application of real command, when driving through bus station or bus stop :

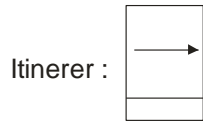

bus stations - bus stops

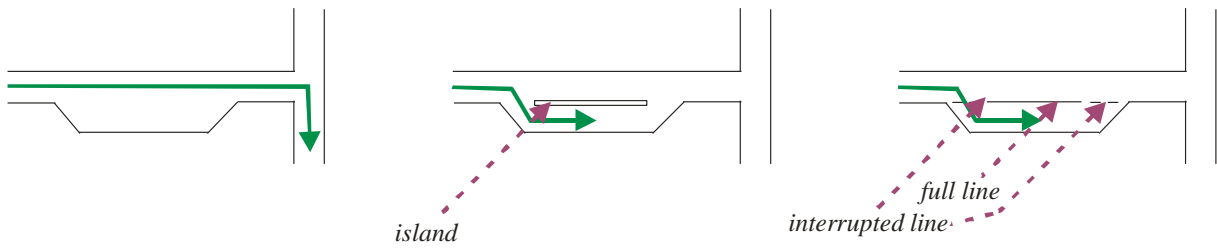

16.8. Navigation on the map from real point to map point

1. Example:

Map:

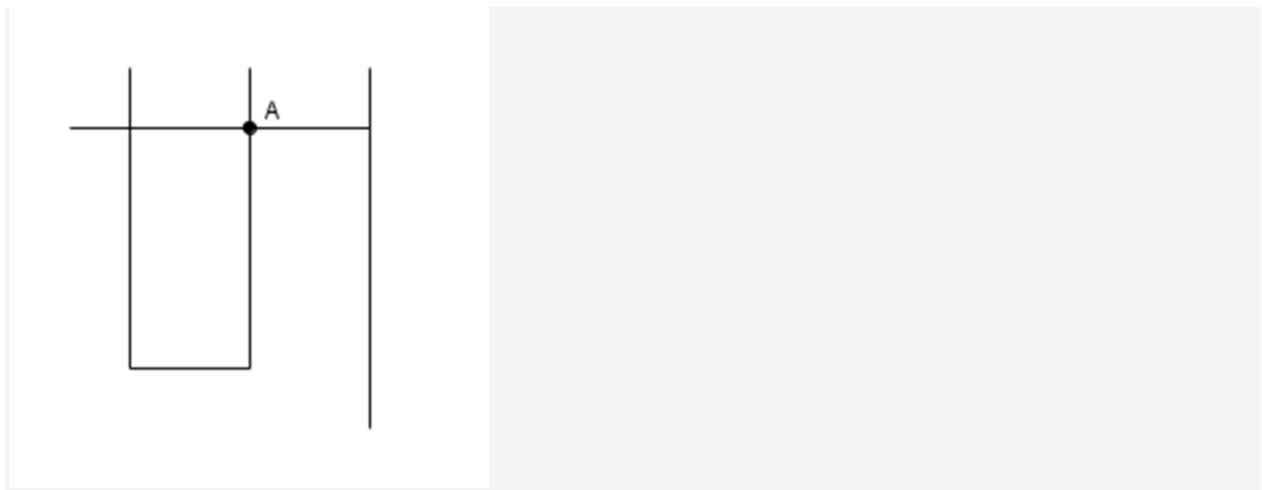

Itiner:

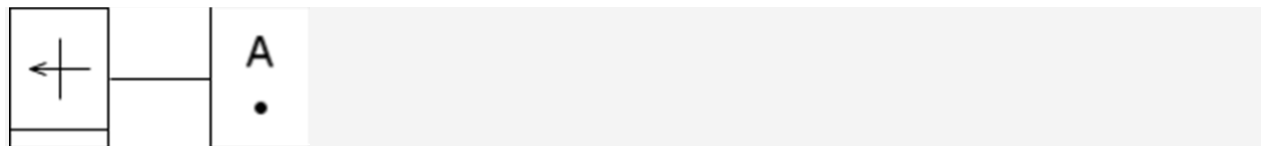

Reality:

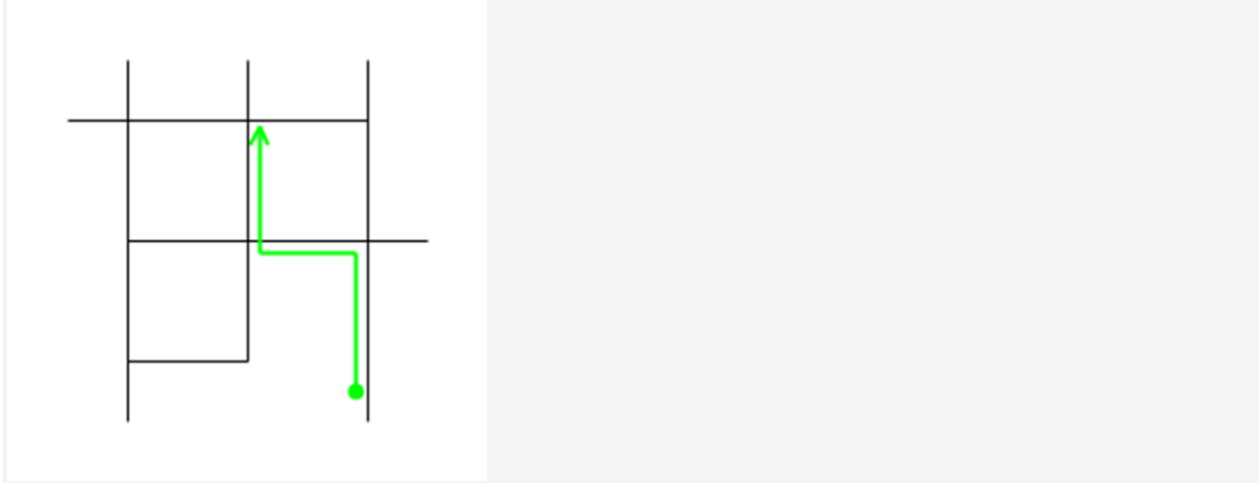

We turn left at the full-cross and we will leave the map. After that we travel according to the navigation rules based on real information until we will be on the map again. When we have arrived back to the map we should find the nearest route to POINT A.

2. Example:

Map:

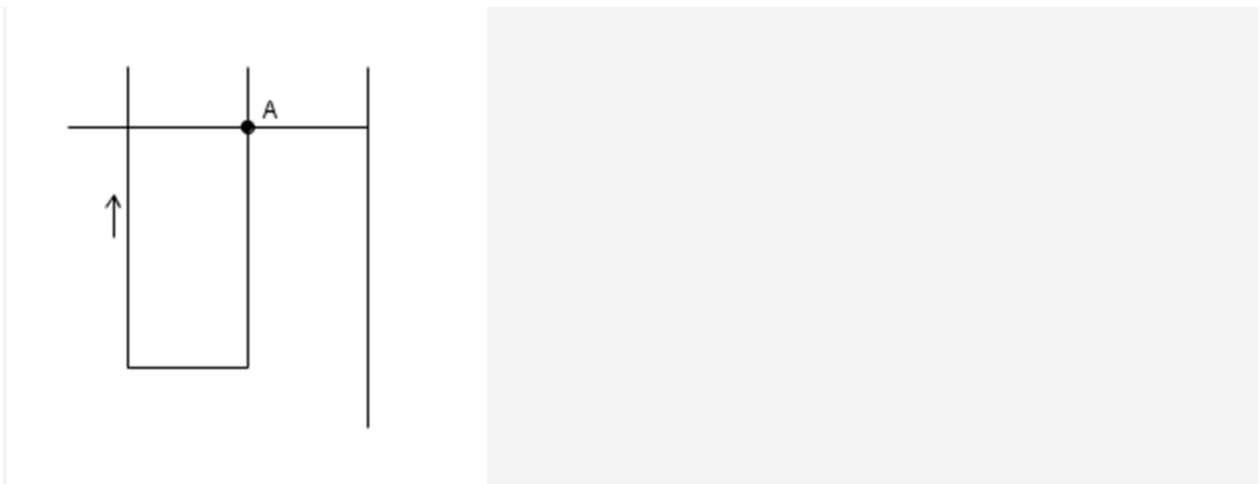

3. Example:

Map:

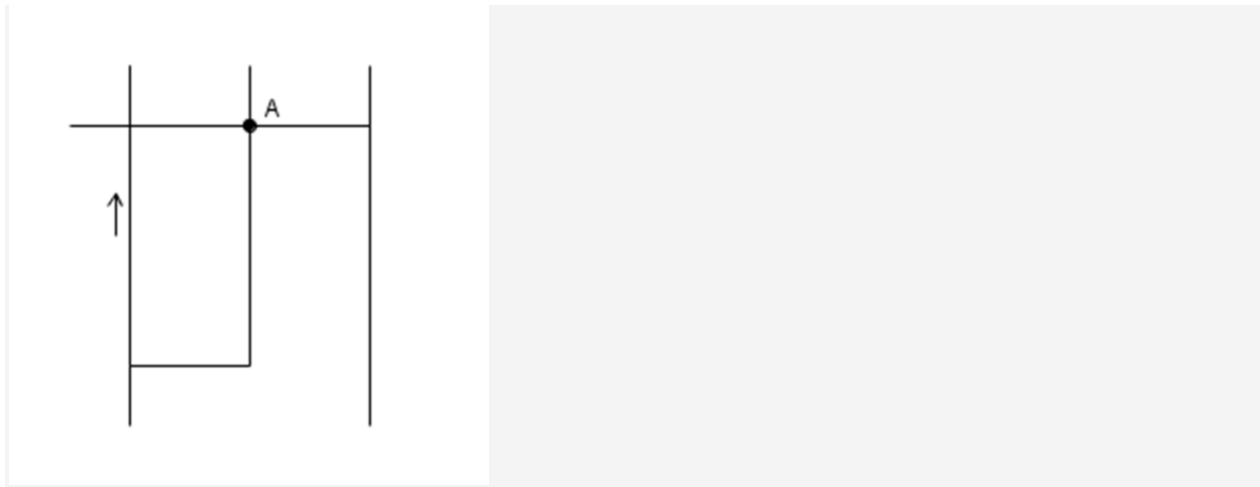

Itiner:

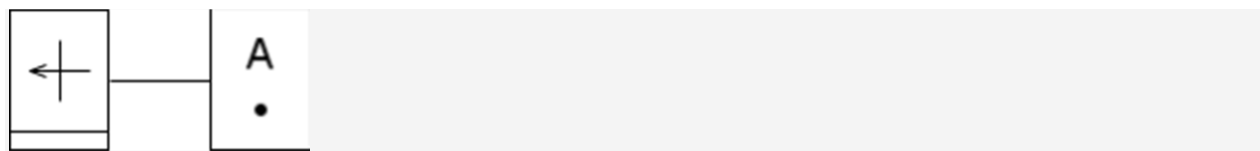

Reality:

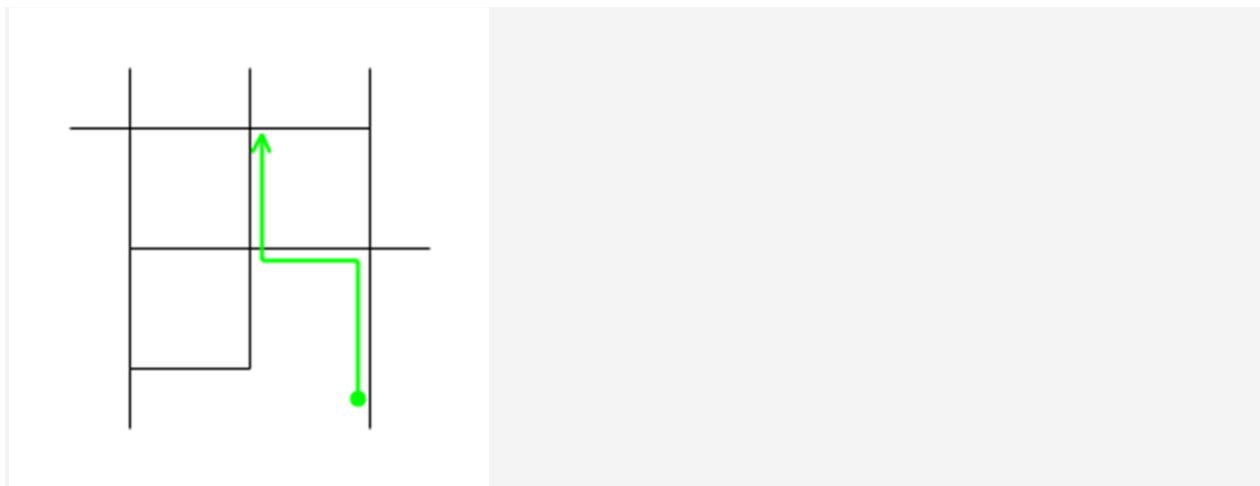

We have a different map again. One way arrow valid only between two crosses, so because of “stick” towards South we will arrive to a street which is not a one way street and we can turn to North.

16.9. Navigation based on real information from real point to map point

1. Example:

Map:

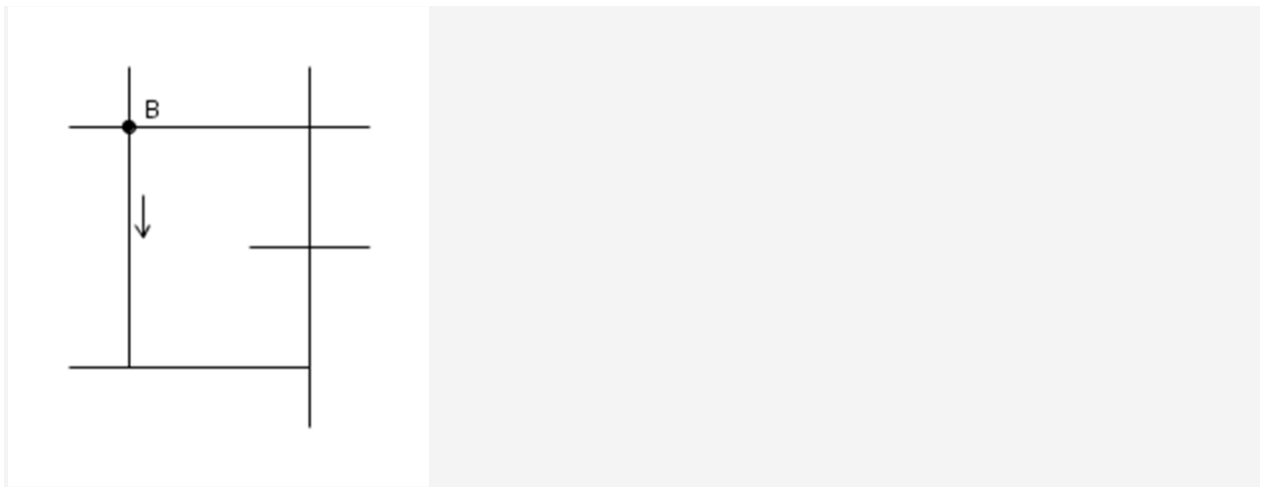

Itiner:

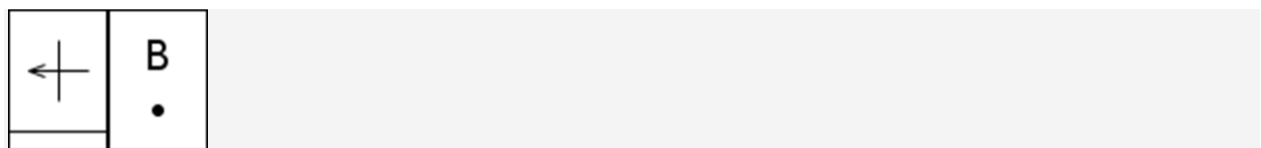

Reality

:

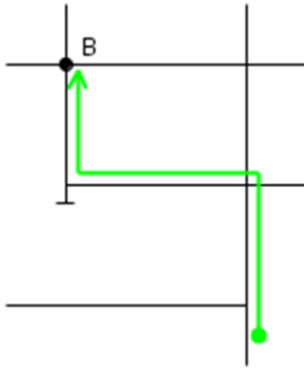

We are travelling according to the navigation rules based on real information until full-cross where we turn left and leave the map but it doesn't matter because we should travel according to the navigation rules based on real information until POINT B. Later we will be at the cross where we have "dead end" from left, so we can move forward only right. Meanwhile we will arrive back to a street which is marked on the map and this is a one way street according to the map, but it still doesn't matter for us because we should arrive to POINT B according to the navigation rules based on real information.

16.10. Navigation based on real information from map point to map point

1. Example:

Map:

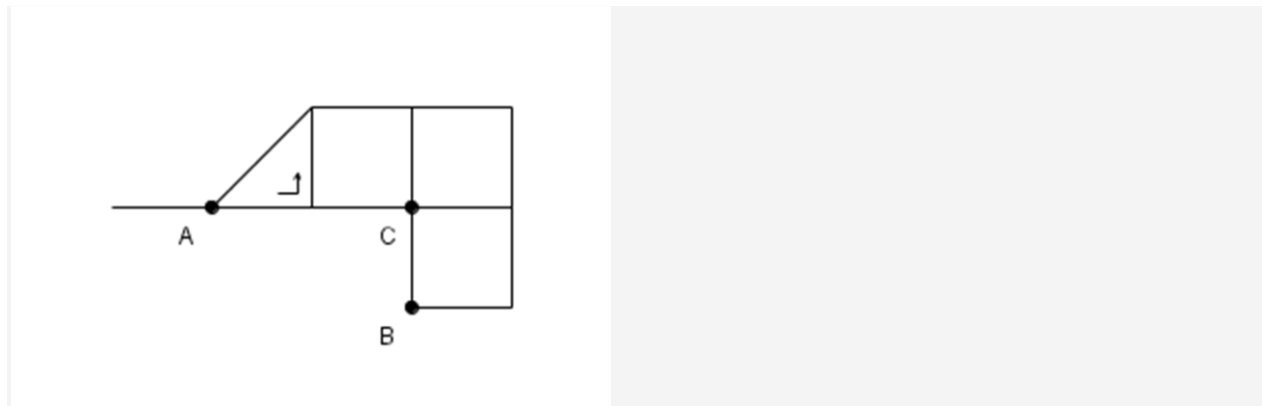

Itiner:

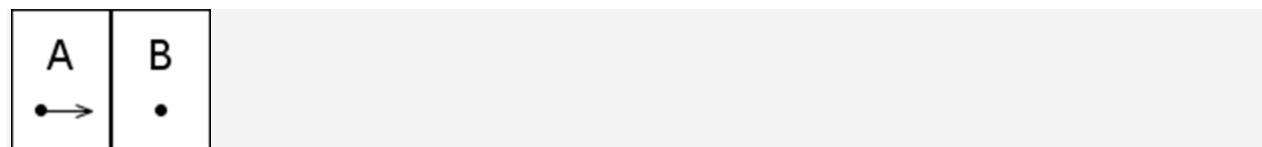

Reality:

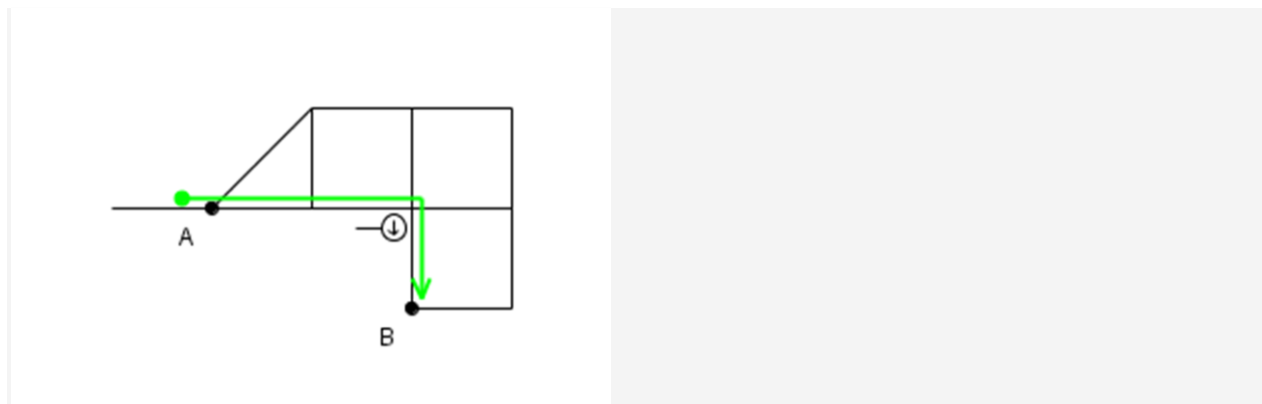

We are travelling from POINT A according to the navigation rules based on real information, so those information which marked on the map doesn't matter for us (e.g. turning arrow and POINT C) until we have arrive to POINT B. But proposed to check where we are travelling on the map during navigation based on real information to know when we will be in POINT B.

16.11. Navigation based on real information from map point to real point

All the examples have the same map:

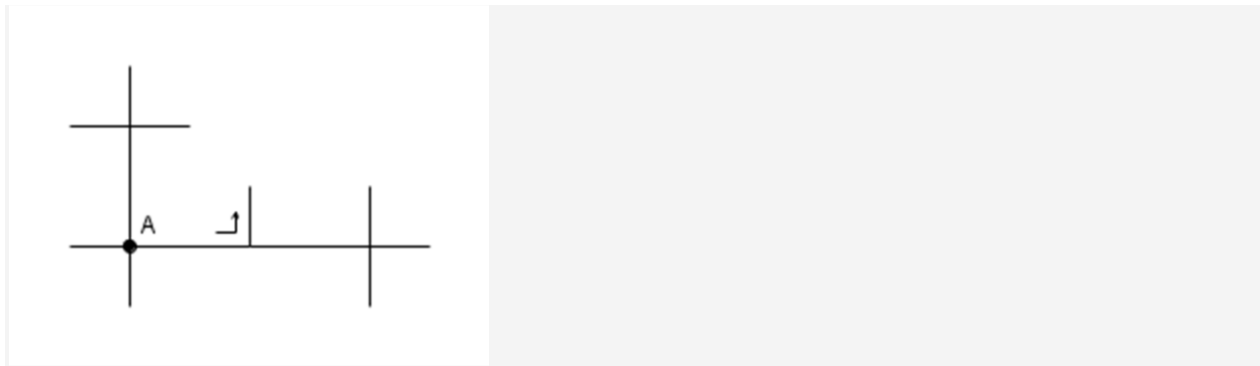

1. Example:

Itiner:

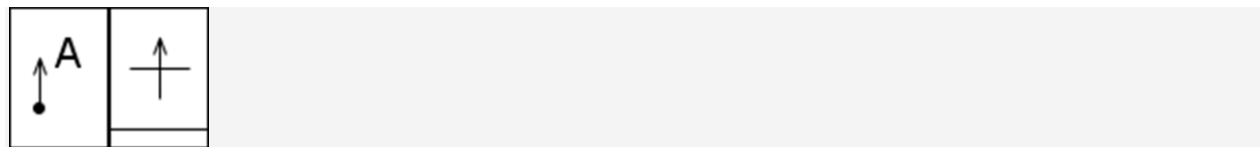

Reality:

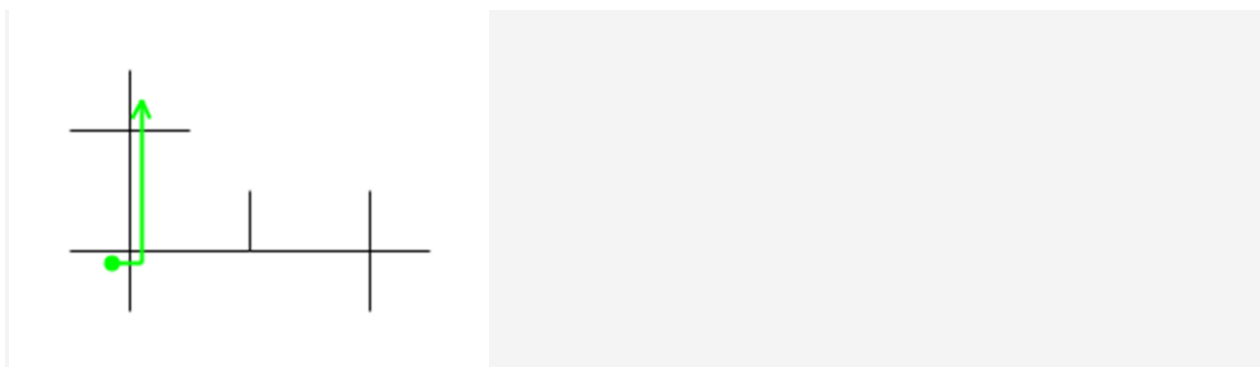

We leave POINT A to North. From there we travel according to the navigation rules based on real information until we find a full-cross.

2. Example:

Itiner:

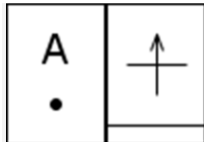

Reality:

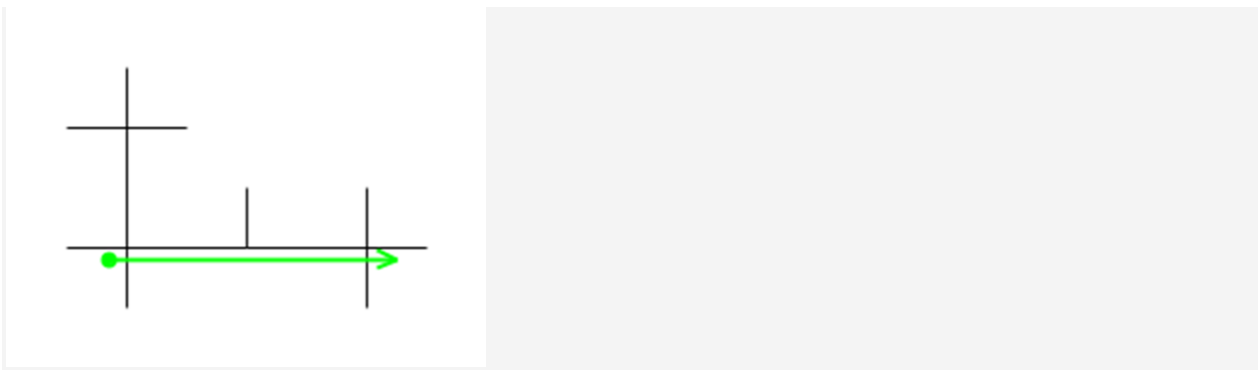

We leave POINT A according to the navigation rules based on real information, so to straightforward. From there we don't check the map just travel until we find a full-cross.

3. Example:

Itiner:

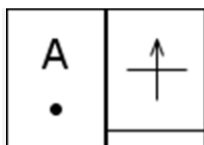

Reality:

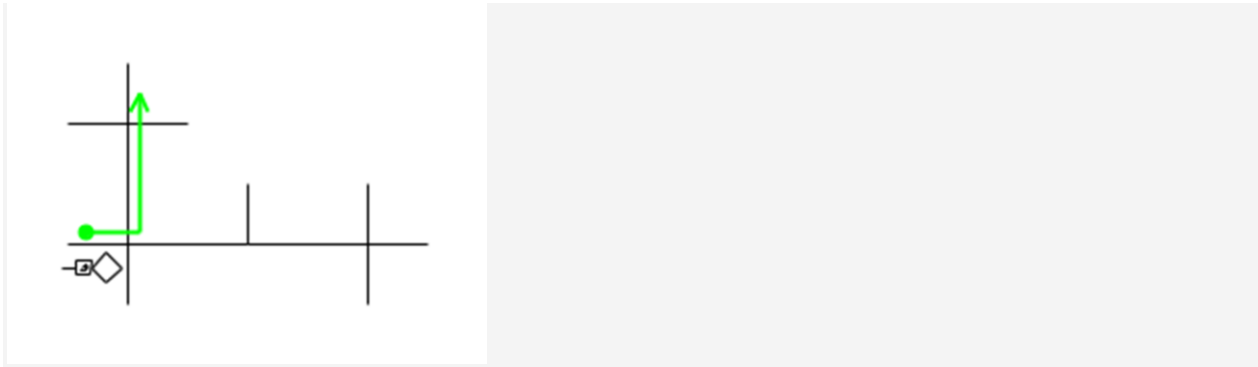

Because of “major road” road sign we should leave POINT A according to navigation rules based on real information, so we will go north.

4. Example:

Itiner:

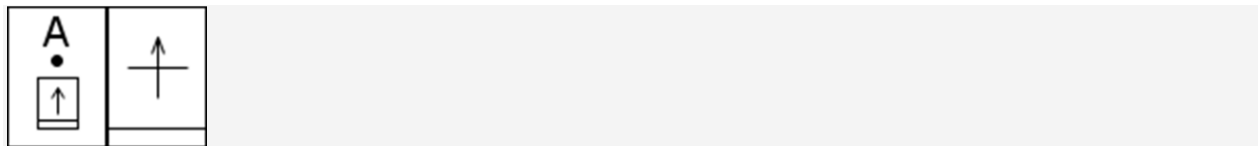

Reality:

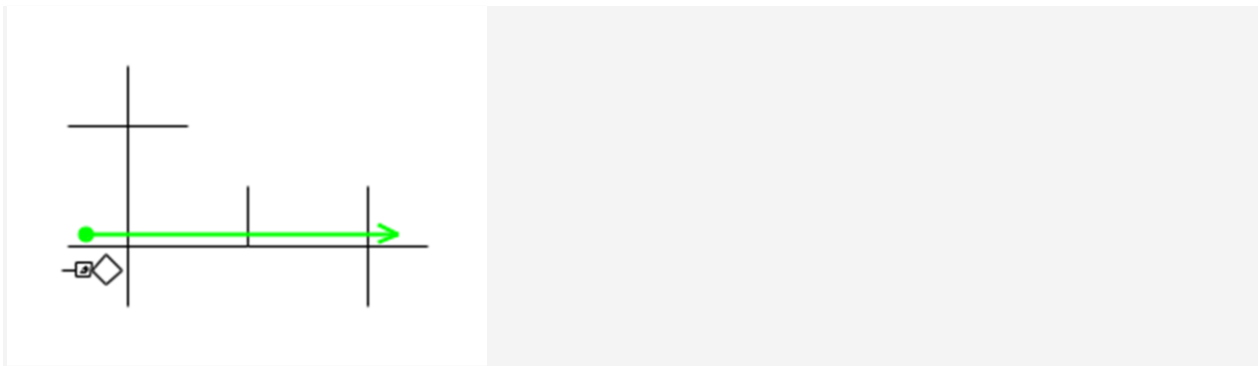

At the POINT A we should go real “straightforward”, so we will pass that cross to East. After that we should travel according to navigation rules based on real information until we will arrive to a full-cross.

16.12. DETAIL

1. Example:

Map:

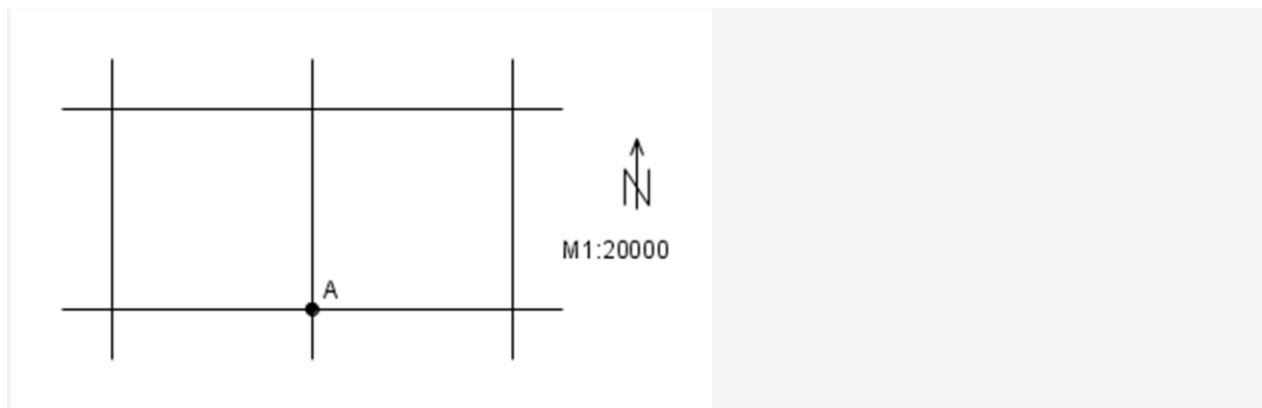

DETAIL:

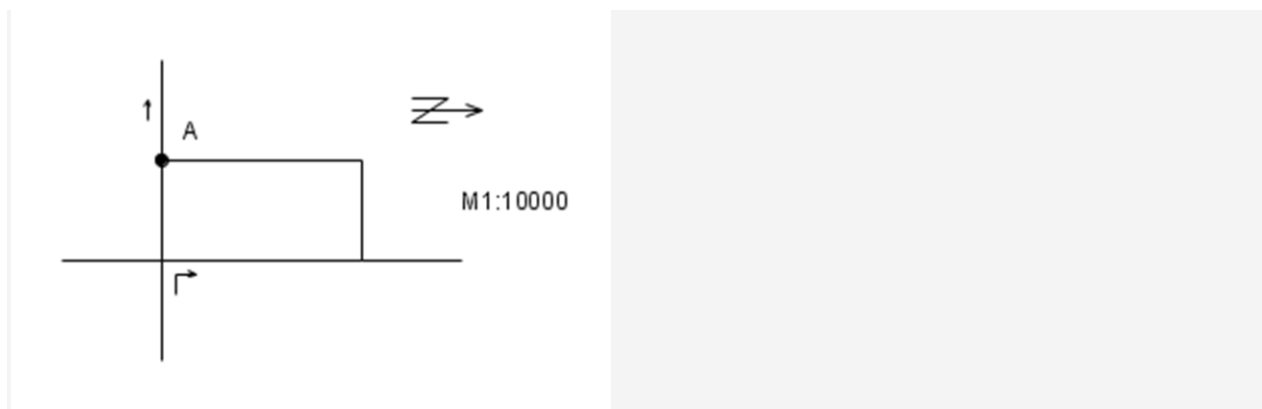



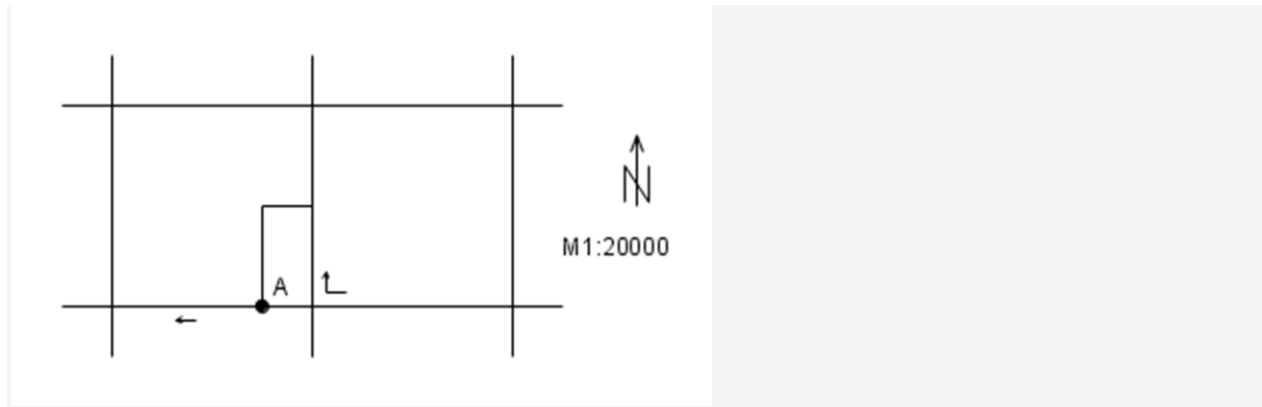





Both of those:



In this example you have different scale and compass between MAP and DETAIL. DETAIL is defining POINT A more precisely. DETAIL is also put a turning arrow and one way arrow into the map.

2. Example: The detail is indicated in the header of the itinerary
This detail is valid for whole stage – from start to finish

	<p>9. a 10. round of 23. year of serial “ The Central European Cup “ Spišská Belá - Slovensko 04.- 05.10.2019</p>		<p>23 year of the serial THE CENTRAL EUROPEAN CUP International Automobile Orientation Competition season 2019</p> 
<p>ETAP : 2N</p>	<p>Time for the stage t = 90 min.</p>	<p>Stage lenght l = 40 km</p>	
<p>Author of track : Ing. Peter Rusiňák</p>		<p>Head referee : Ing. Ivan Sabaka</p>	
<p>Detail 407</p> 			
<p>ČK1</p>		<p>600</p> 	<p>131</p> 
<p>141</p> 		<p>251</p> 	
<p>etc.</p>			

This detail is valid for whole stage - from start to finish

3. Example: The detail is marked on the map



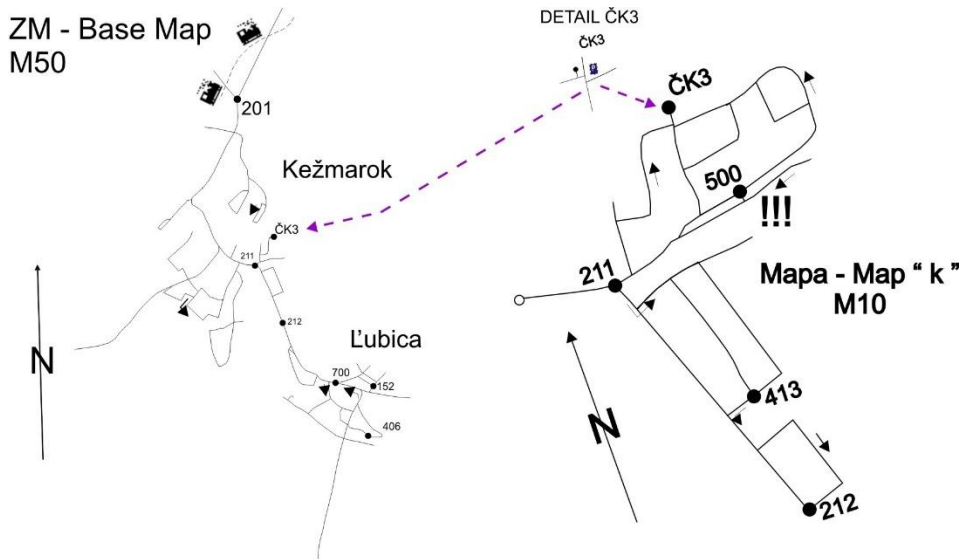

This detail is valid for whole stage – from start to finish



This detail is valid for whole stage - from start to finish

4. Example: The detail is marked on the map.

This detail is valid for whole stage – from start to finish

	<p>9. a 10. round of 23. year of serial "The Central European Cup" Spišská Belá - Slovensko 04.- 05.10.2019</p>		<p>23 year of the serial THE CENTRAL EUROPEAN CUP International Automobile Orientation Competition season 2019</p> 
<p>ETAP : 2N</p>	<p>Time for the stage t = 90 min.</p>	<p>Stage lenght l = 40 km</p>	
<p>Author of track : Ing. Peter Rusiňák</p>		<p>Head referee : Ing. Ivan Sabaka</p>	
<p>etc.</p>			
<p>ČK1</p>		<p>131</p>	<p>141</p>
<p>Detail 407</p> 			
<p>1.section</p>			
<p>138</p>		<p>402</p>	<p>ČK2</p>
<p>etc.</p>			
<p>2.section</p>			

This detail is valid only for 1.section of stage

16.13. CONSTANT

1. Example:

CONSTANT:

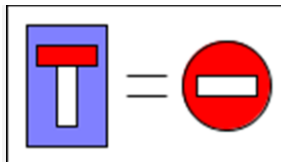

Itiner:

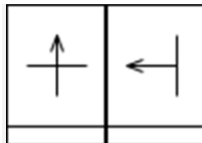

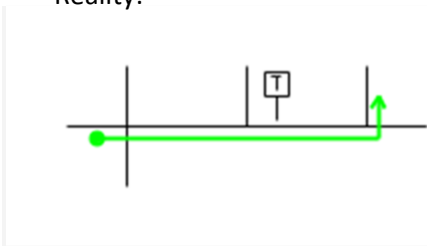

Reality:

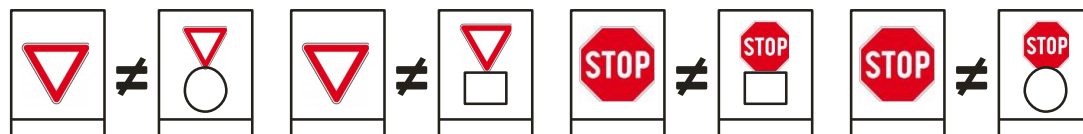
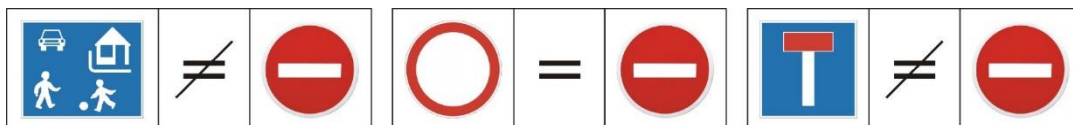

Based on CONSTANT information "dead end" means "no entry", so we don't need to turn left at the first cross

2. Example: Other examples of constant :



XX =  =  - not permitted entry into street, where checkpoint "XX" sign is displayed

16.14. CONDITION

1. Example:

Itiner:

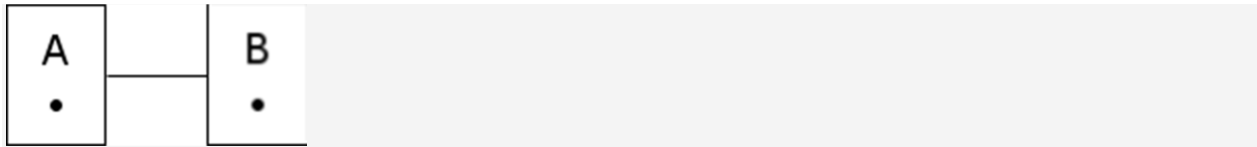

CONDITION:

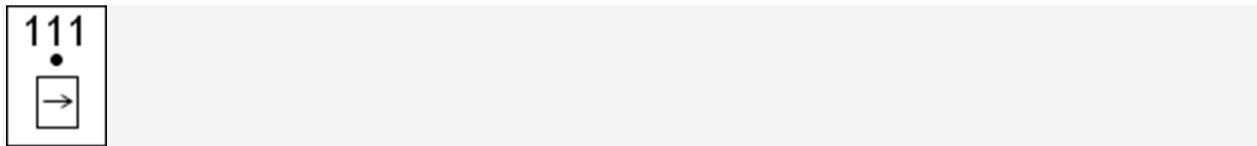

Map:

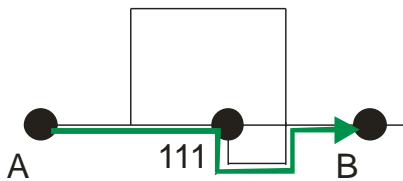

or

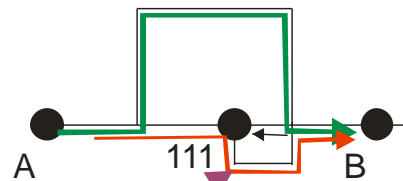

in point 111 is map commanded direction
- condition is not applicable = wrong (red) way

Based on CONDITION we should turn right on the map at POINT 111, so when we are planning the route to POINT B we should plan with CONDITION as well and shortest way will be if we arrive from West to POINT 111 drive according to CONDITION and arrive to POINT B from West.

or

Based on CONDITION we should turn right on the map at POINT 111, so when we are planning the route to POINT B we should plan with CONDITION as well and shortest way will be if we no arrive to POINT 111, because in point 111 in condition not applicable (map commanded direction is no the same as trun right) and arrive to POINT B from West.

2. Example:

Itiner:

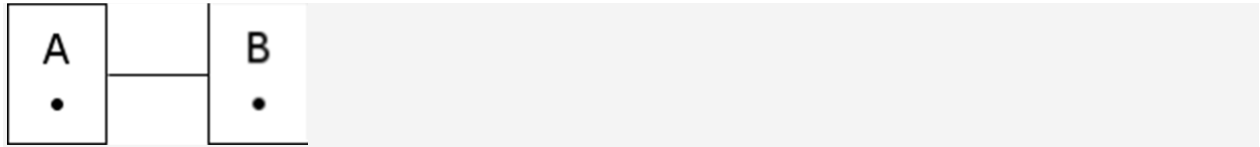

CONDITION:

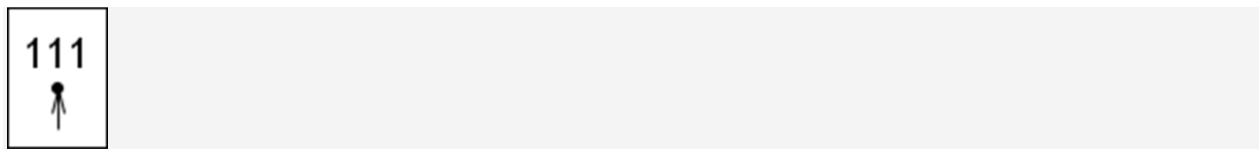

Map:

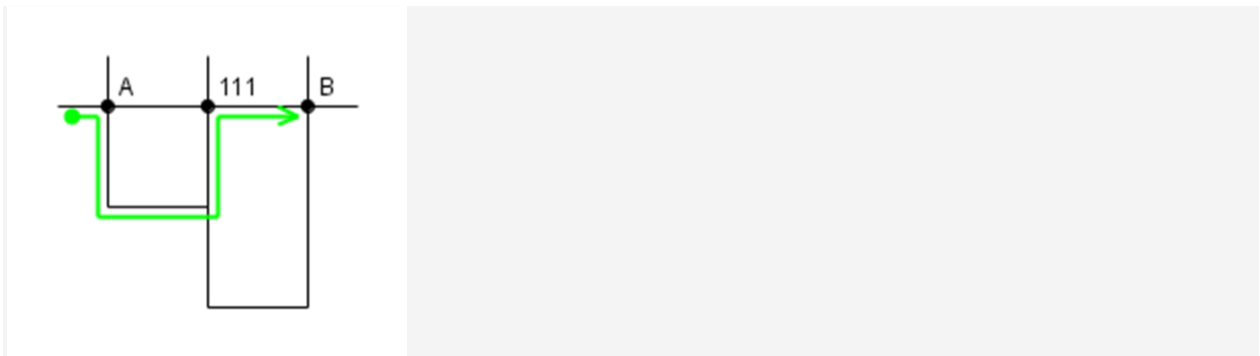

We should arrive to POINT 111 only from South.

3. Example:

Itiner:

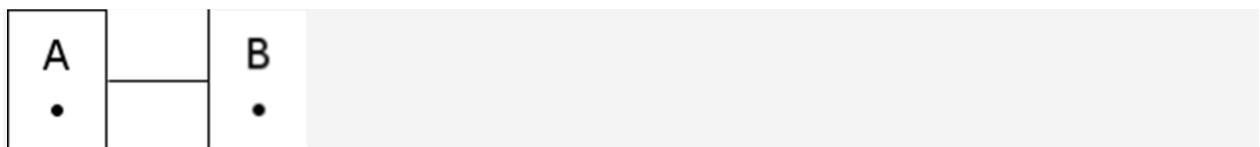

CONDITION:

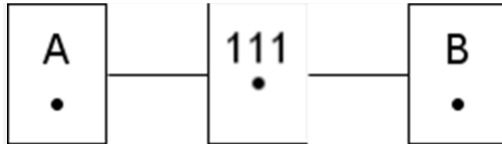

Map:

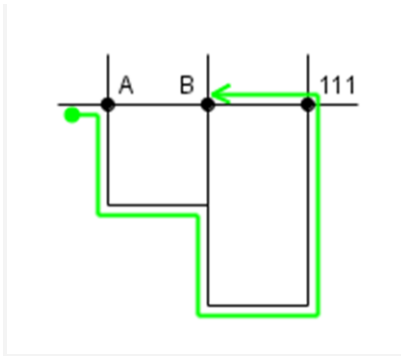

Based on CONDITION we should reach POINT 111 when we are planning our route between POINT A and POINT B.

4. Example:

Itiner:



CONDITION:

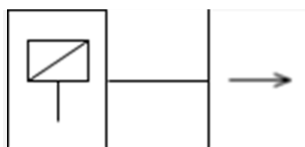

Map:

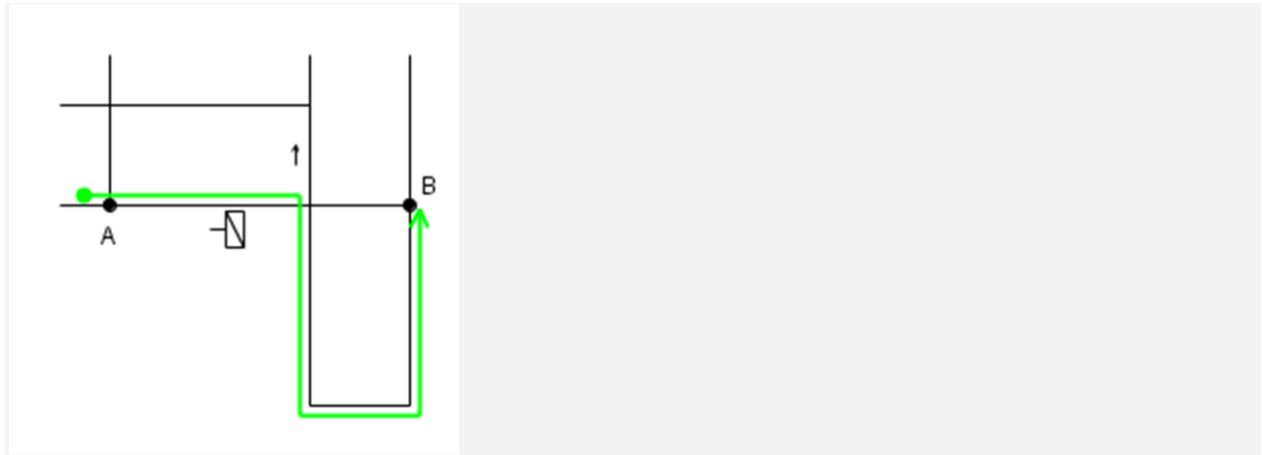

We should start our route from POINT A to POINT B only to East because no any other way. So, we should pass next to the mentioned road sign and after that based on CONDITION we should find the nearest right turn on the map. After we have turned to South at the cross we should find the shortest way to POINT B which is quite simple now.

5. Example:

Itiner:

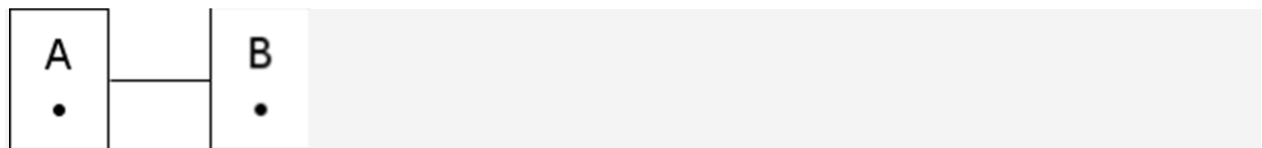

CONDITION:

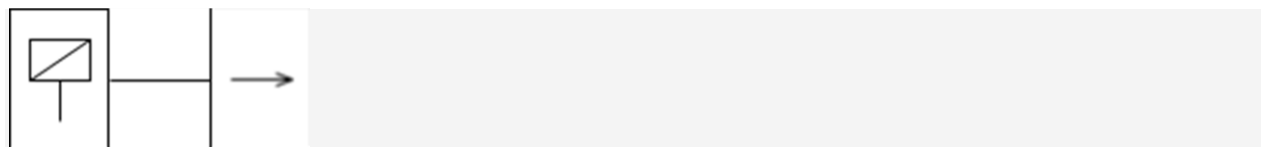

Map:

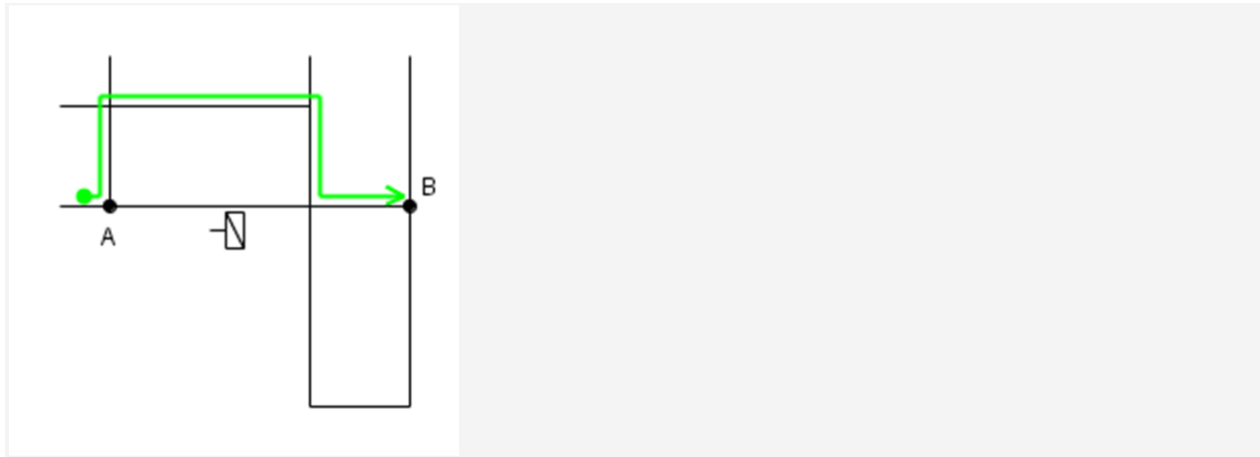

That street which was one way street on the previous map it is a normal street now. If we plan our route from POINT A to East then we will get “town is over” road sign and we will turn right on the map at the next cross. But if we plan a route from POINT A to North then we will get shorter route then in the previous case.

6. Example:

Itiner:

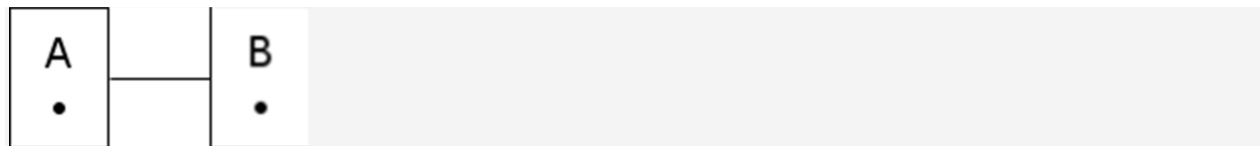

CONDITION:

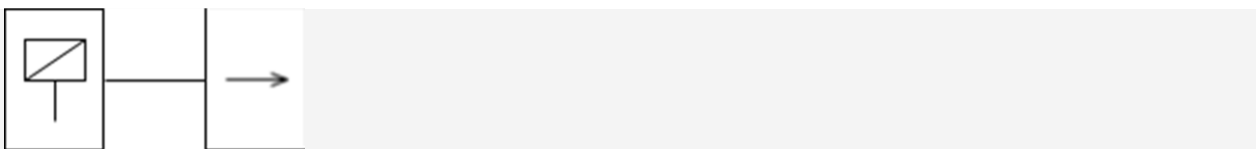

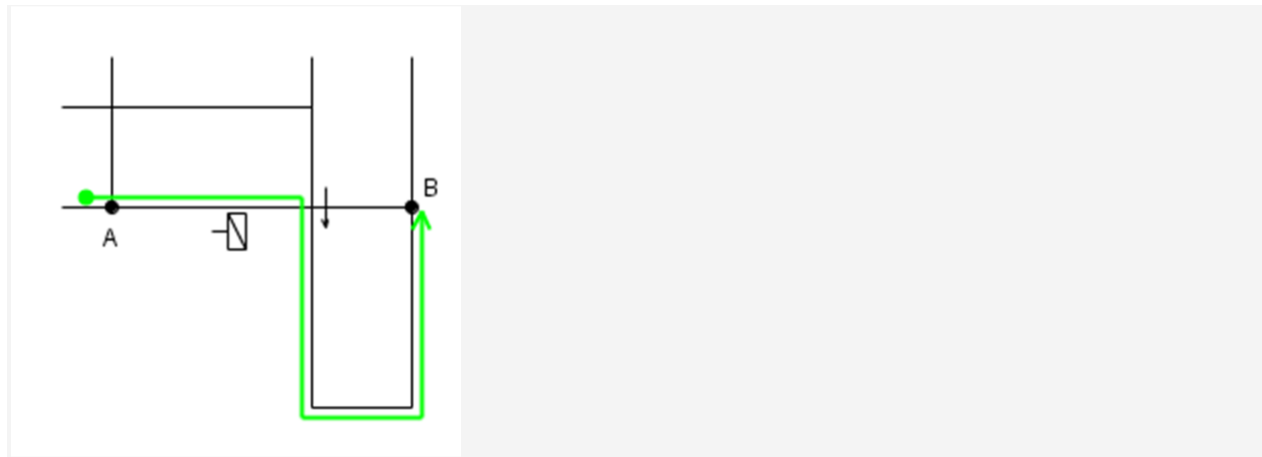

Map:



Now, we have a turning arrow on the map, so if we would like to use that route which was correct at the previous example then we will get longer route, so now we should leave POINT A to East for the shortest route.

7. Example:



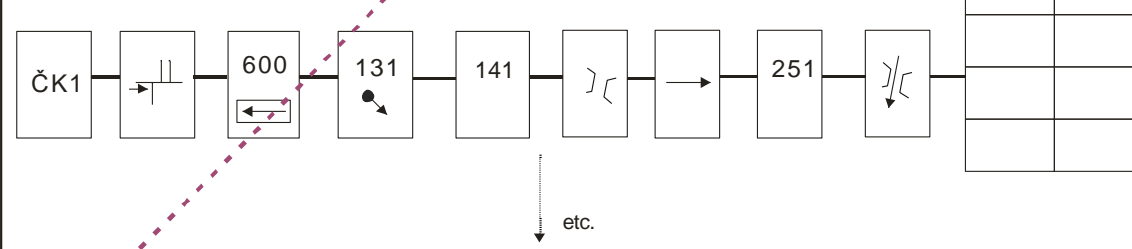

The condition is written in the top of the itinerary.

	<p align="center">9. a 10. round of 23. year of serial “ The Central European Cup “ Spišská Belá - Slovensko 04.- 05.10.2019</p>		<p align="center">23 year of the serial THE CENTRAL EUROPEAN CUP International Automobile Orientation Competition season 2019</p> 
<p>ETAP : 2N</p>	<p>Time for the stage t = 90 min.</p>	<p>Stage length l = 40 km</p>	
<p>Author of track : Ing. Peter Rusiňák</p>		<p>Head referee : Ing. Ivan Sabaka</p>	
<p align="center">Condition</p> <p align="center">100 ÷ 199 → ←</p>			
			

This condition is valid for whole stage - from start to finish

8. Example:

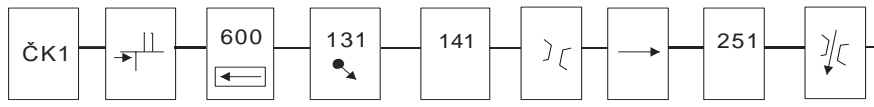

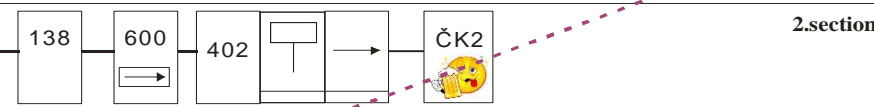
The condition is written in the section of stage.

	9. a 10. round of 23. year of serial “ The Central European Cup “ Spišská Belá - Slovensko 04.- 05.10.2019				
	ETAP : 2N	Time for the stage t = 90 min.		Stage lenght l = 40 km	
Author of track : Ing. Peter Rusiňák		Head referee : Ing. Ivan Sabaka			
etc.					
	Condition1 		1.section		
etc.					
			2.section		
etc.					

This condition is valid only for 1.section of stage

or

The condition is written in the marked sector of stage.

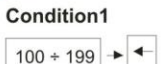
	9. a 10. round of 23. year of serial “ The Central European Cup “ Spišská Belá - Slovensko 04.- 05.10.2019				
	ETAP : 2N	Time for the stage t = 90 min.		Stage lenght l = 40 km	
Author of track : Ing. Peter Rusiňák		Head referee : Ing. Ivan Sabaka			
etc.					
	Condition1 				
etc.					

This condition is valid only for marked.sector of stage

9. Example:

The condition is written to the specific map.

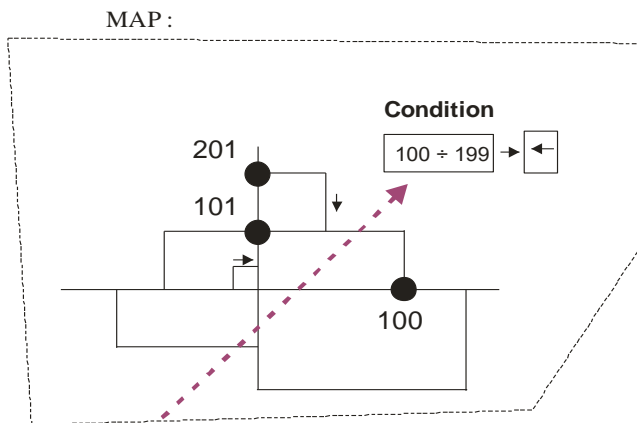
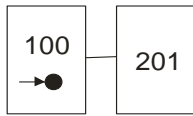

Reality :

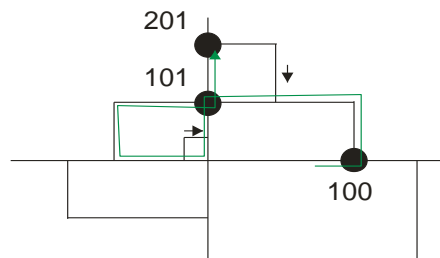

This condition is valid only for this specific map

or

The condition is written to the specific map and SM – driving rule for SM.

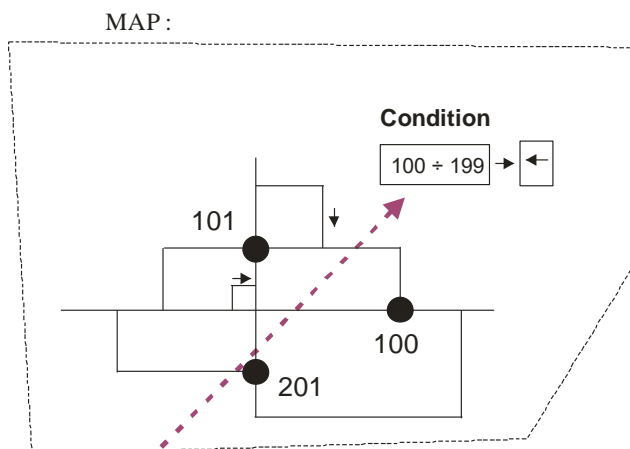
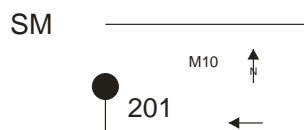
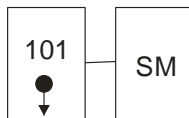

Reality :

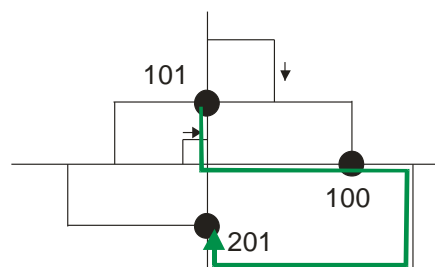

This condition is valid only for this specific map, SM is another map, therefore this condition is not valid for SM

10. Example:

The condition is written to the SM.

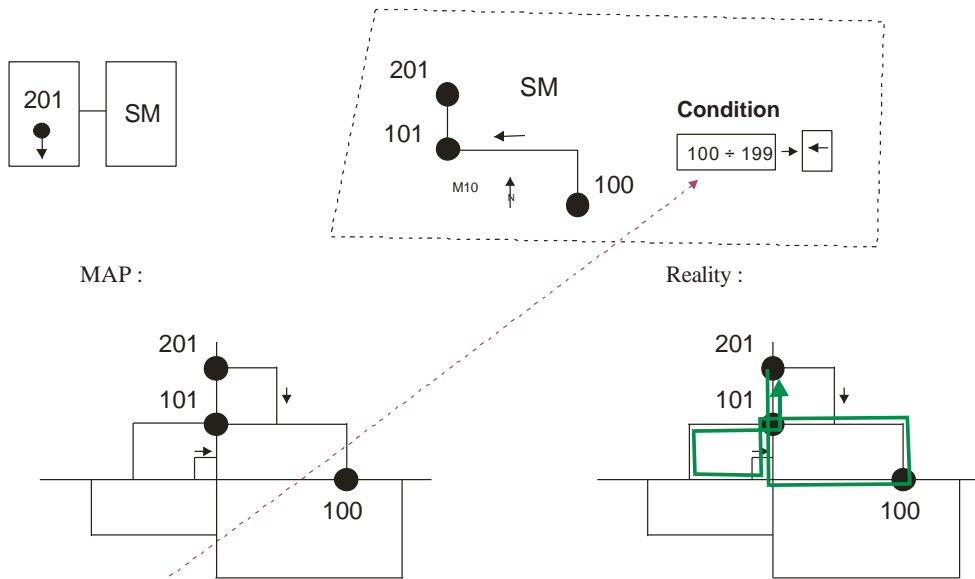

This condition is valid only for SM, MAP is another map, therefore this condition is not valid for MAP . (at leaving of SM and returning to SM is condition not valid)

11. Example: Do not use !!! - for track authors

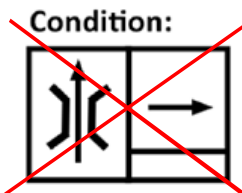

12. Example: Each condition, or inserted itinerary, is a separate itinerary entry and cannot be combined. One condition should not affect another condition or inserted itinerary.

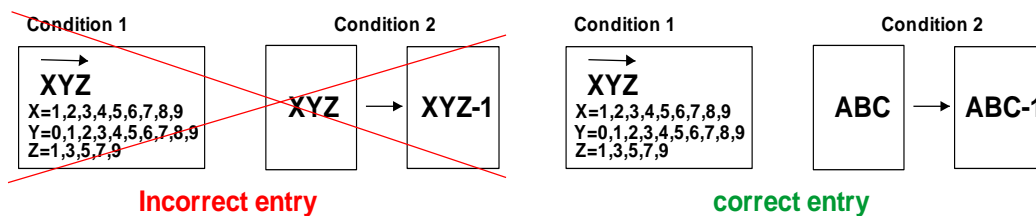

16.15. INSERT

1. Example:

Itiner:

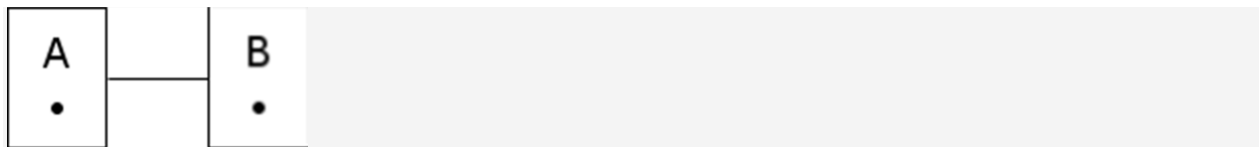

INSERT :

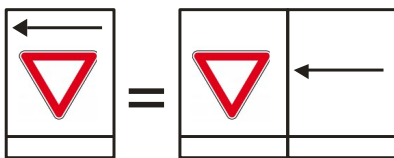

Reality:

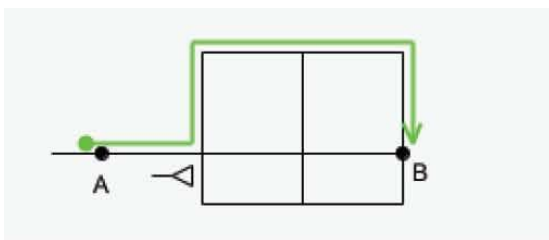

You should turn left at the cross where the sign is located because of Insert.

2. Example:

Itiner:

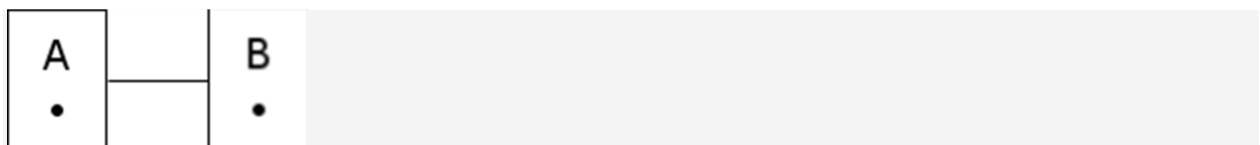

INSERT:

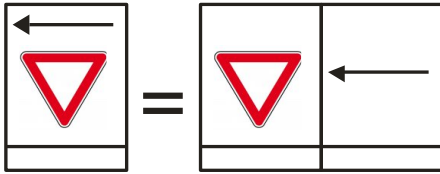

Reality:

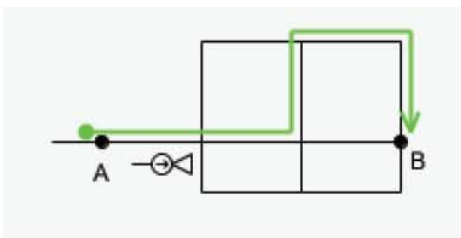

You cannot turn left at the cross where the sign is located because of complementary straight sign but you can do this at the next cross, so you should do there because Insert is still valid.

3. Example:

Itiner:

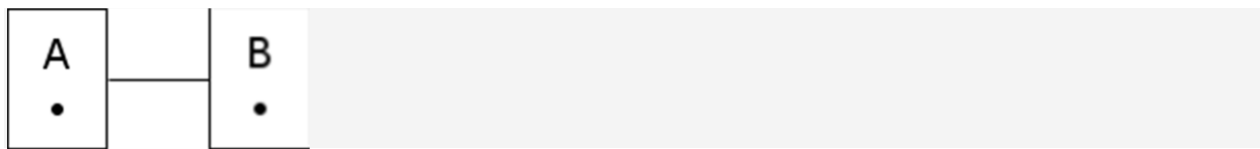

INSERT:

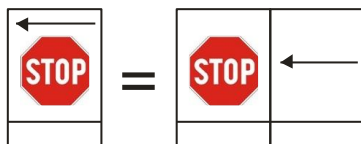

- behind each traffic sign "STOP" always turn left

MAP :

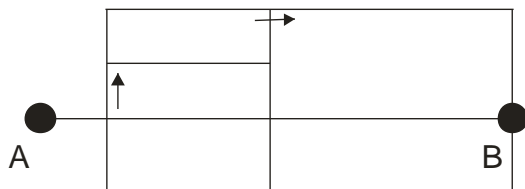

Reality :

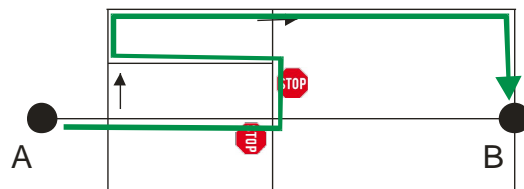

You should turn left always at the cross where the traffic sign is located because of Insert.

4. Example:

Itiner:

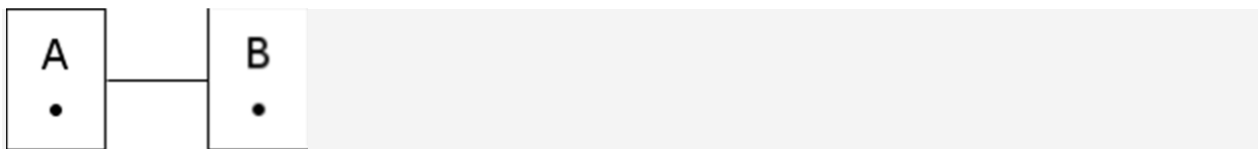

INSERT :

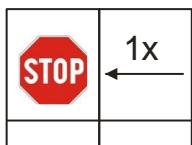

- behind each traffic sign "STOP" first time turn left

MAP :

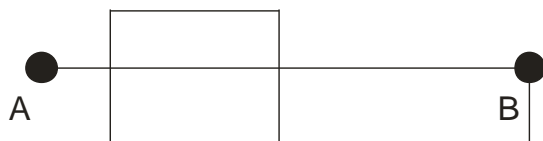

Reality :

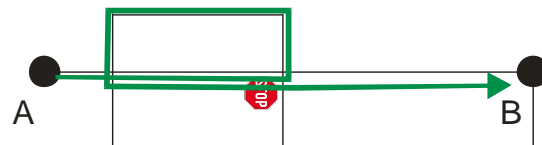

You should turn left first time at the cross where the traffic sign is located because of Insert.

5. Example:

Itiner:

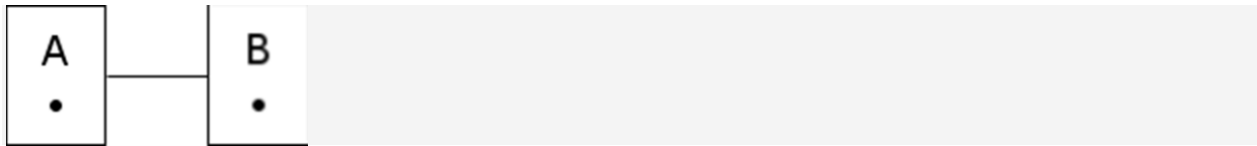

INSERT :

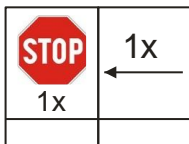

- behind first traffic sign "STOP" first time turn left

MAP :



Reality :

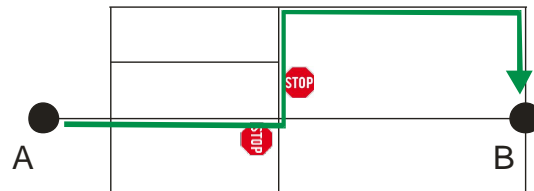

You should turn left first time at the cross where the first traffic sign is located because of Insert.

6. Example:

Itiner:

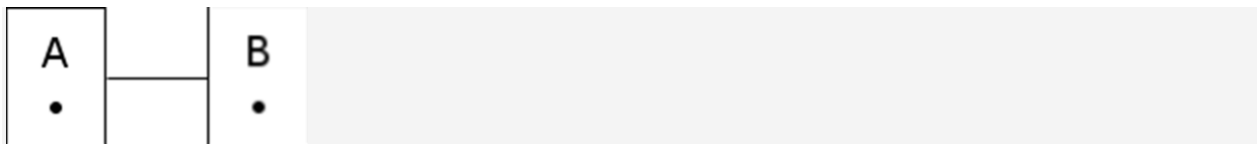

INSERT :



- behind traffic sign of this type turnright after 0,30 km

MAP :

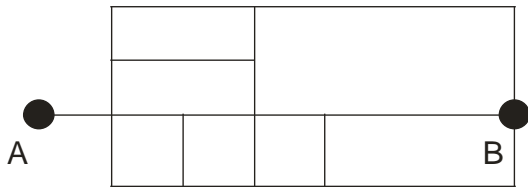

Reality :

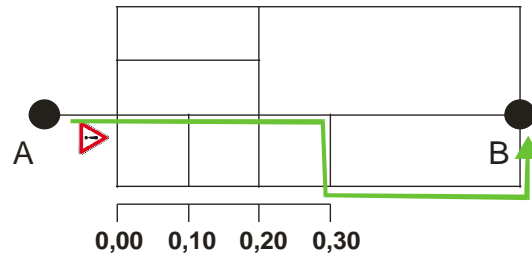

7. Example:

Itiner:

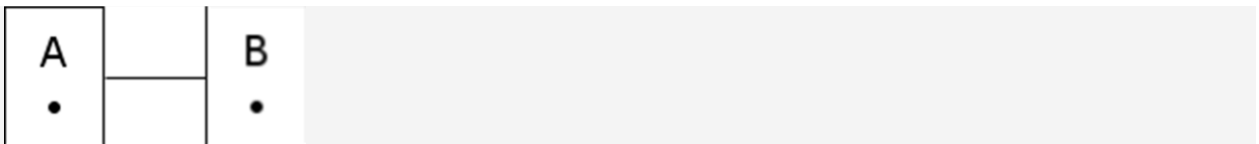

INSERT:

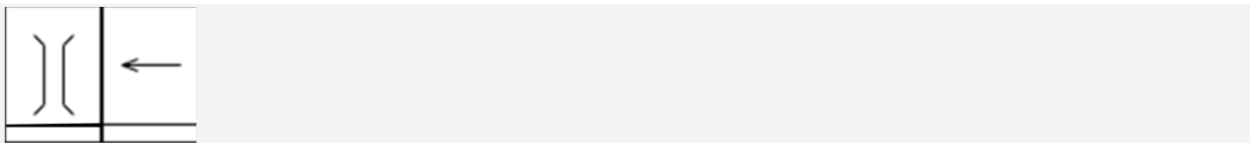

MAP:

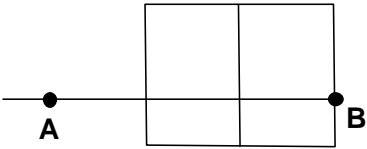

REAL:

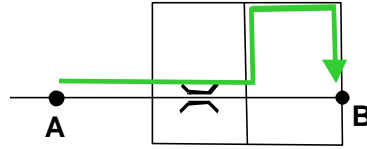

You can get the Insert at the bridge and you can turn left at the first possibility. You can see the differences from Condition here because you are not calculating with Insert before you will be at the bridge.

8. Example:

Itiner:

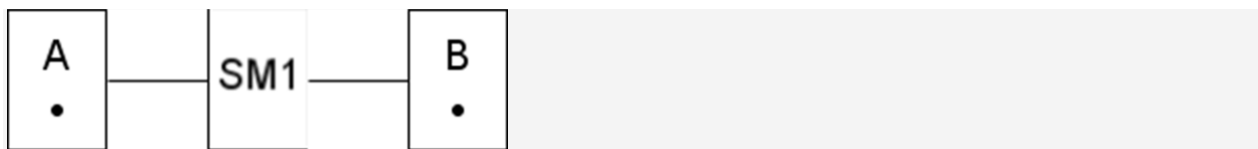

INSERT:

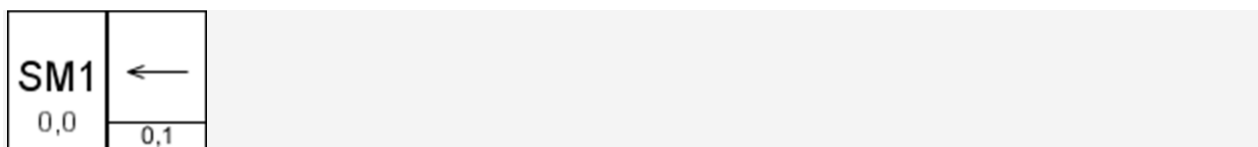

SM1:

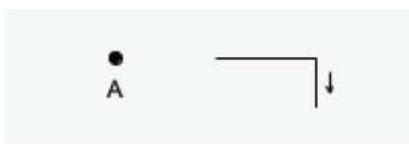

10. Example:

The insert is written in the section of stage.

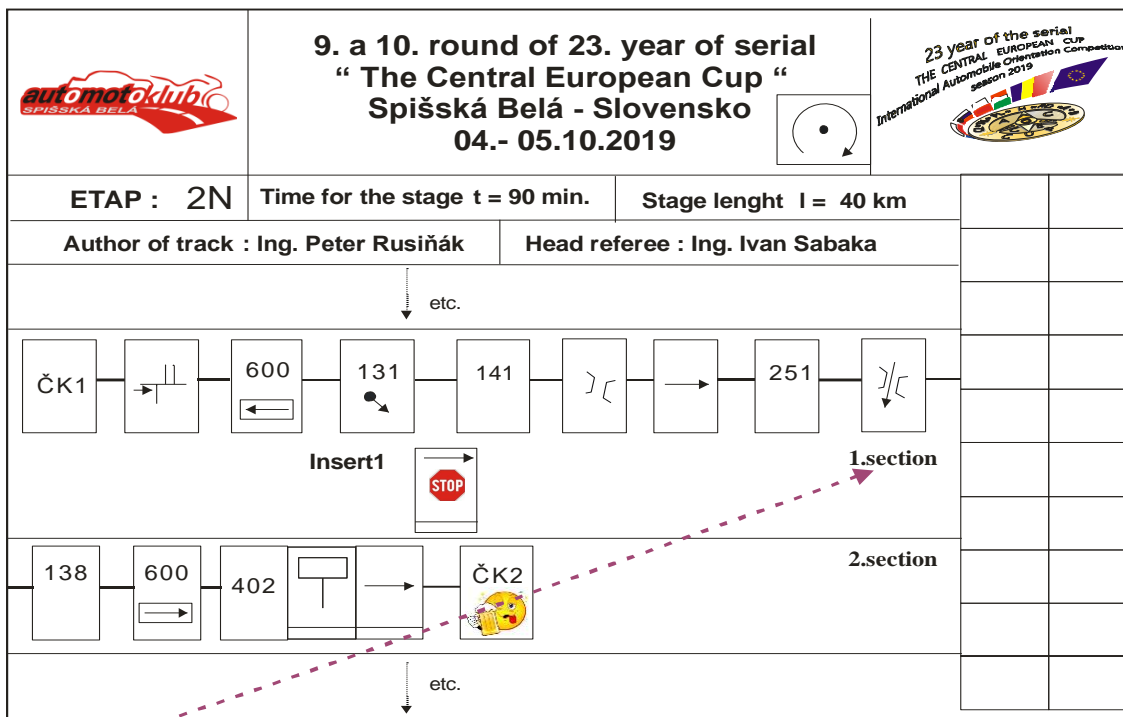

This insert is valid only for 1.section of stage

or

The insert is written in the marked sector of stage.

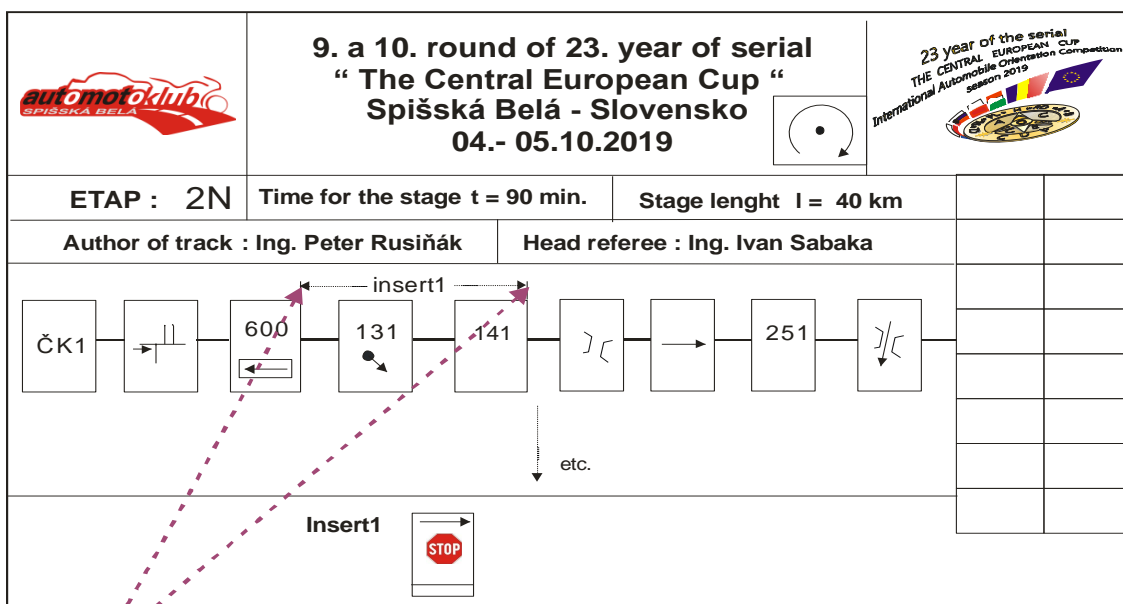

This insert is valid only for marked.sector of stage

11. Example:

The insert is written to the specific map.

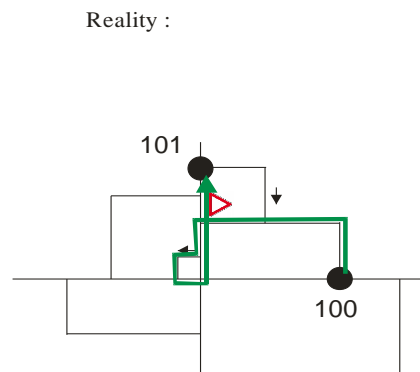
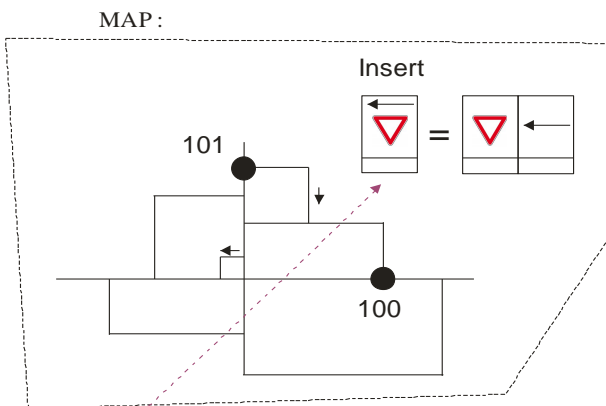
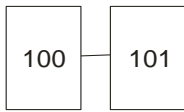

This insert is valid only for this specific map

or

The insert is written to the specific map and SM – driving rule for SM.

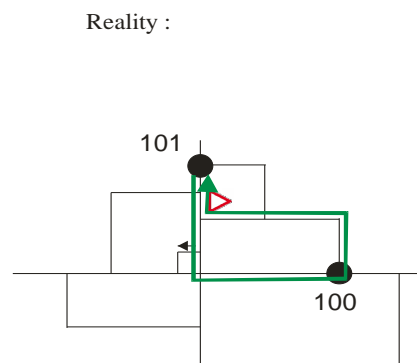
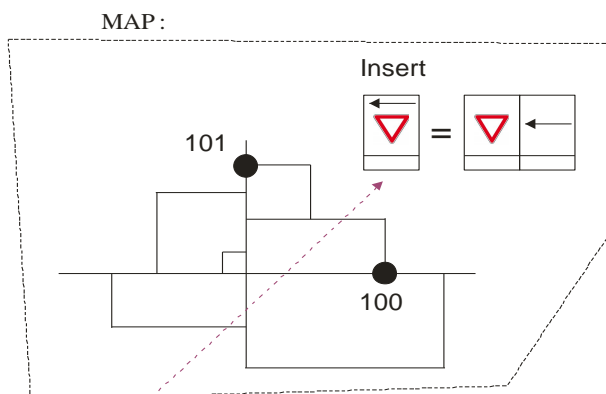
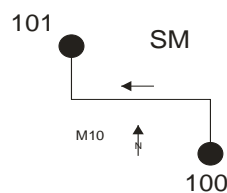
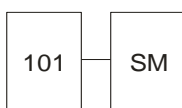

This insert is valid only for this specific map, SM is another map, therefore this insert is not valid for SM.

12. Example:

The insert is written to the SM.

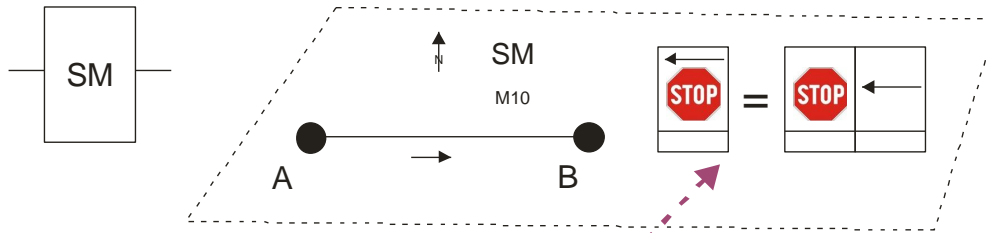

MAP:

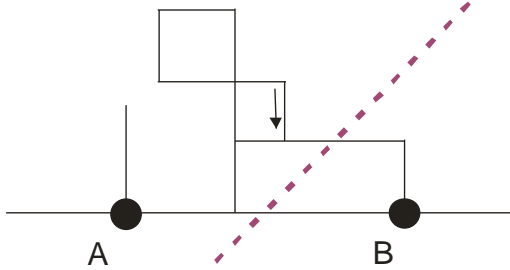

Reality:

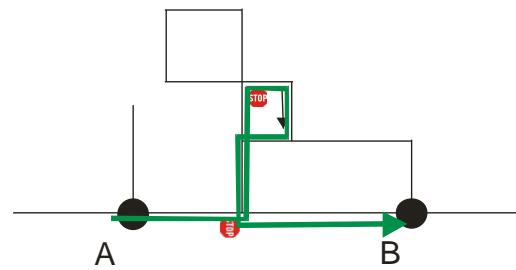

This insert is valid only for SM, MAP is another map, therefore this insert is not valid for MAP. (at leaving of SM and returning to SM is insert not valid)

13.examples : correct and incorrect use of the insert

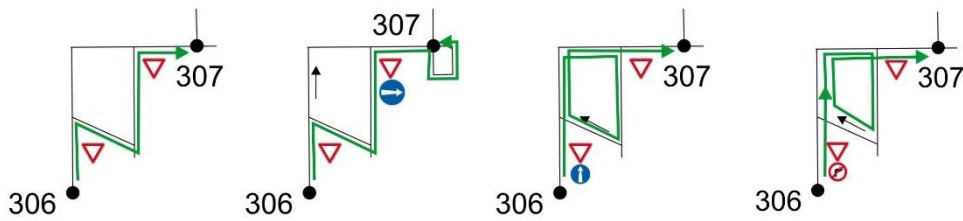
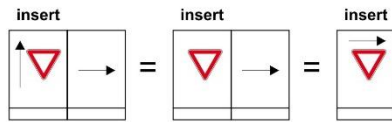
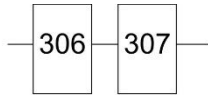

correct entry of the tracks

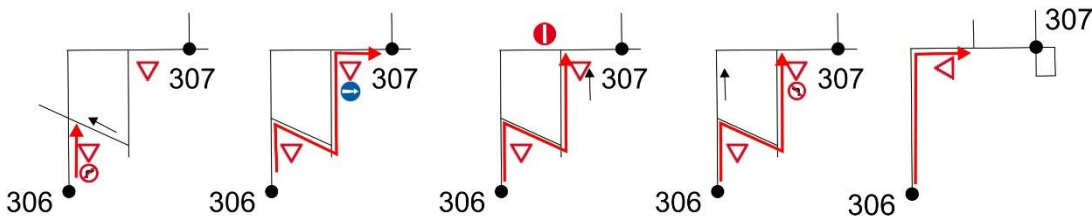

incorrect entry of the tracks

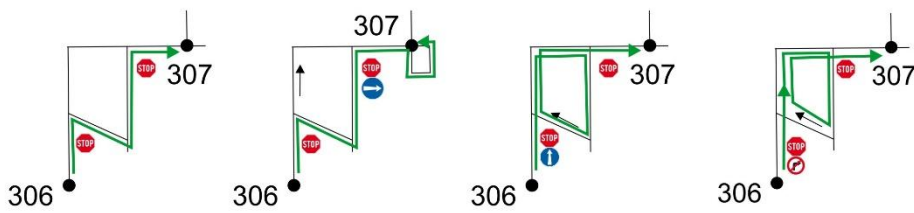
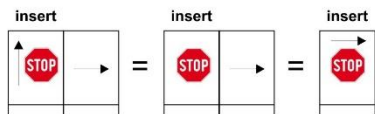
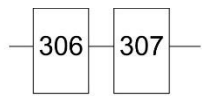

correct entry of the tracks

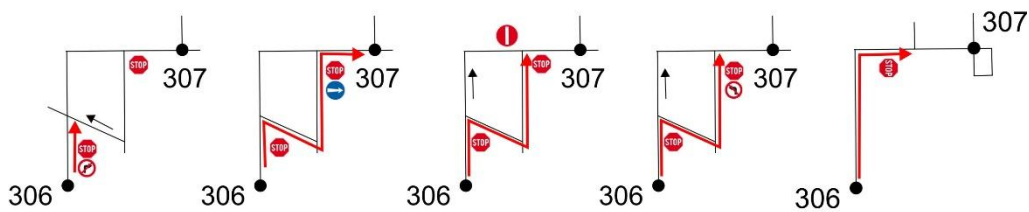

incorrect entry of the tracks

16.16. SM

1. Example:

Itiner:

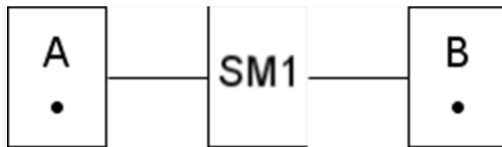

Map:

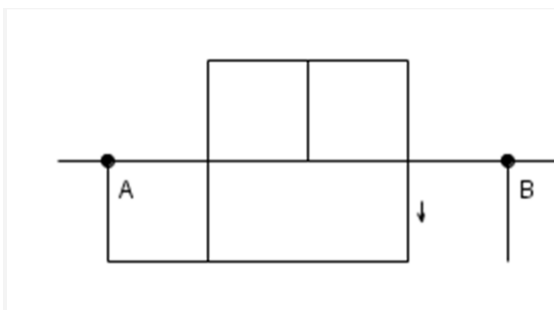

SM1:

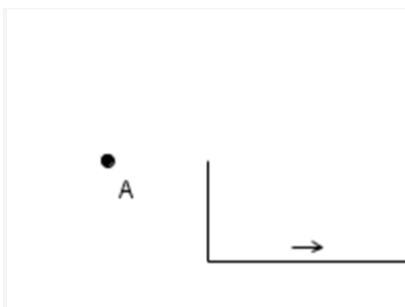

Correct route:

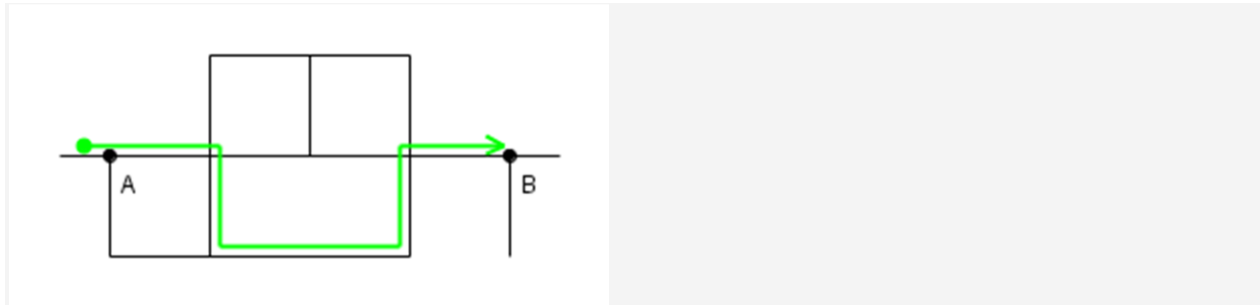

After we have passed POINT A we should plan a route on the map to the starting point of SM1. From that point we should go through on SM1 bypass all the information on the map (bypass the one way arrow). After SM1 we should navigate according to the map again to the shortest route to POINT B.

2. Example:

Itiner:

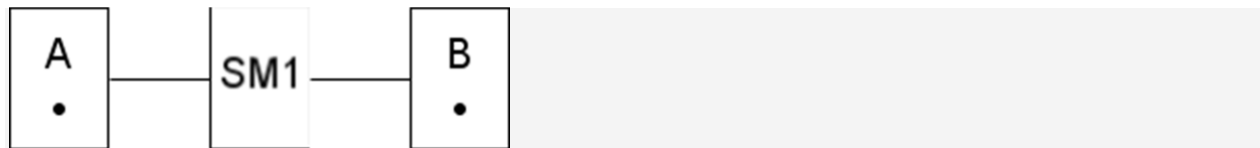

Map:

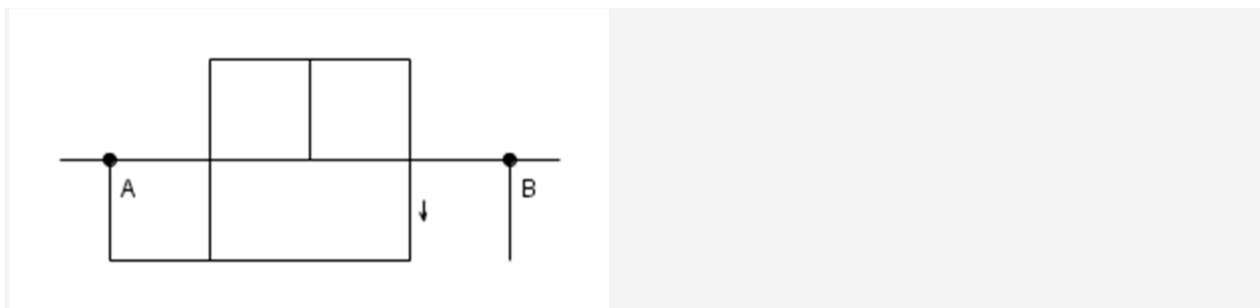

SM1:

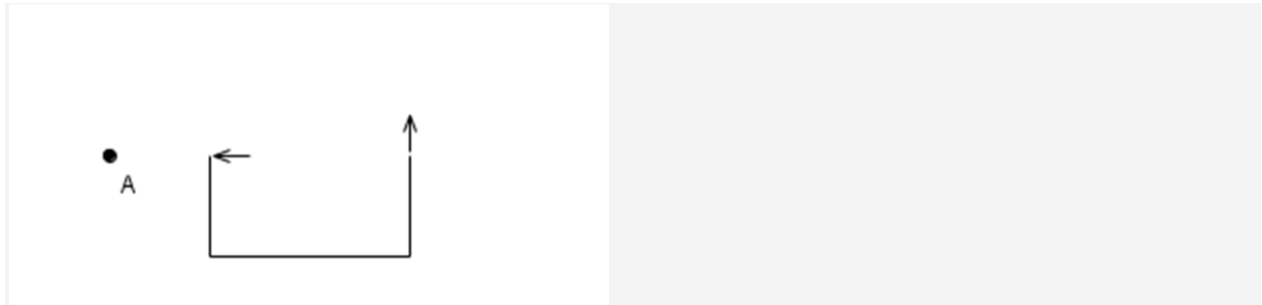

Correct route:

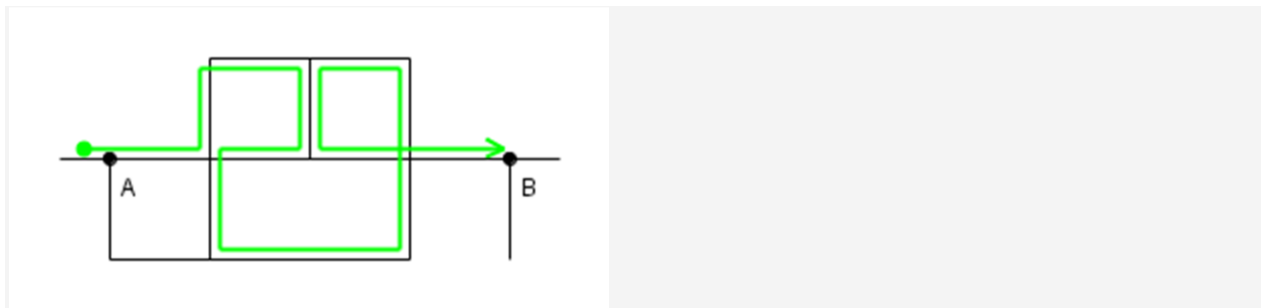

We have arrival and departure directions at SM1. We should plan a route from POINT A where we can arrive at the start of SM1 from East. We should leave SM1 to North and after that we should plan the shortest route to POINT B.

3. Example:

Itiner:

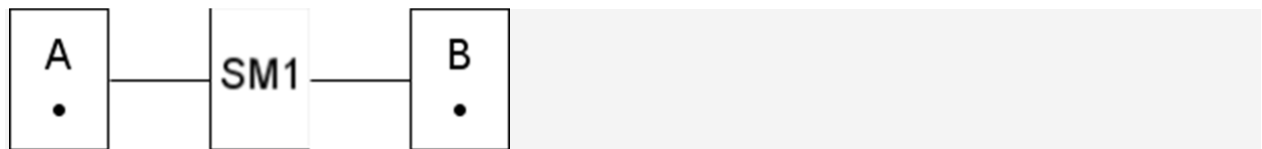

Map:

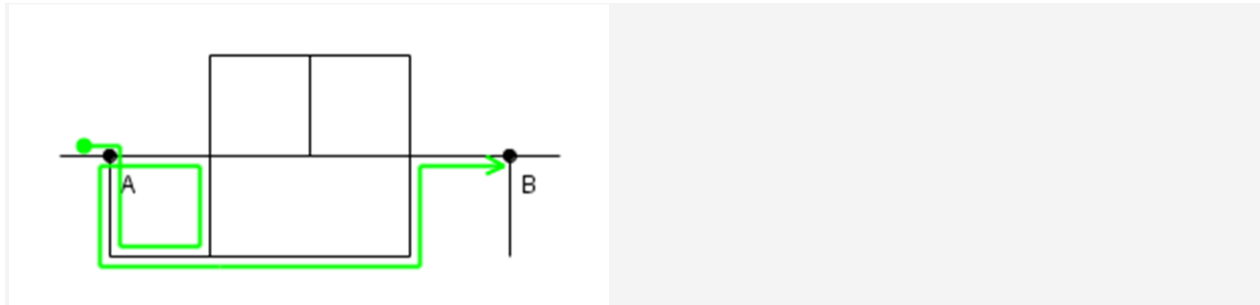

SM1:

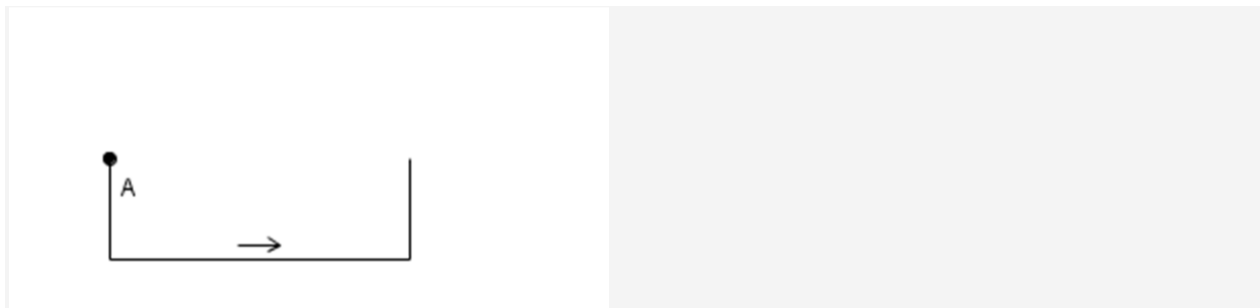

Correct route:

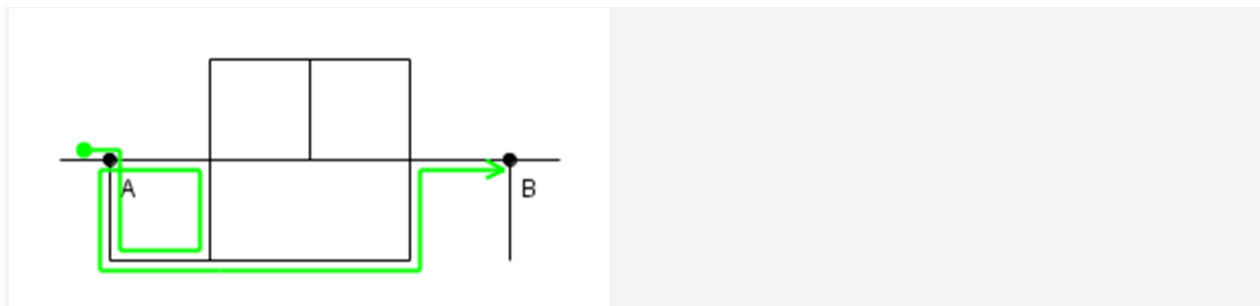

We should turn around in the square (it is similar when we should plan a route from a map POINT to the same map POINT again) to start SM1. We should realize that we cannot use turning order because if we would like to turning in that square from the opposite direction then we won't be able to start SM1.

4. Example:

It is a more complex example where we should interrupt SM1:

Itiner:

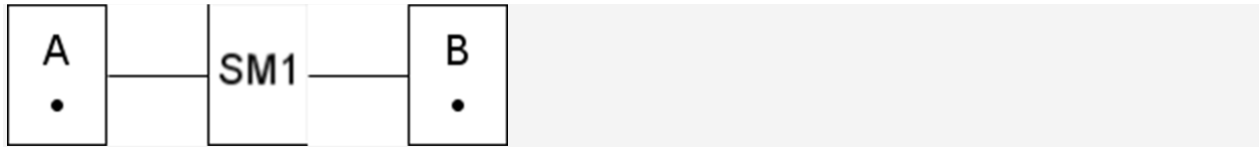

Map (Base Map):

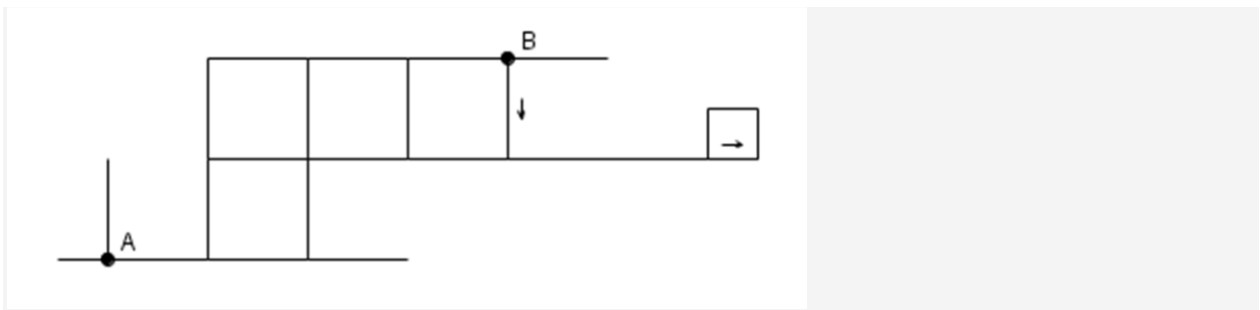

SM1:



Reality:

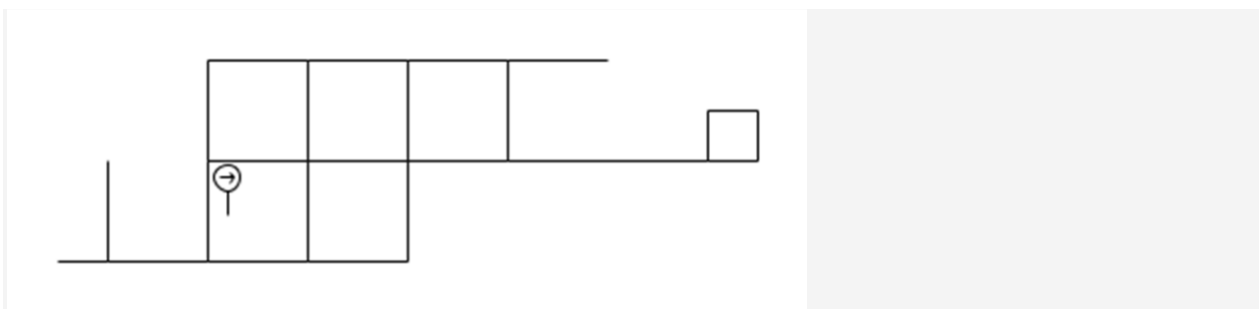

6. Example – the inserting points and subjects to the base map by SM :

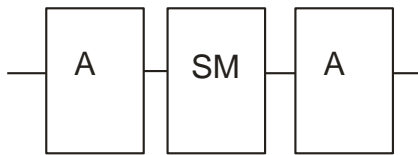

base map (before passing of the SM) :

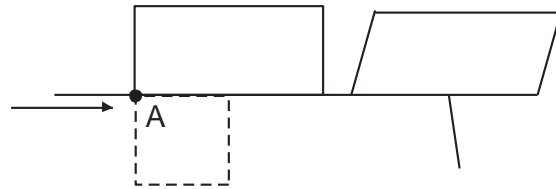

SM

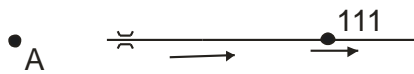

base map (after passing of the SM) :

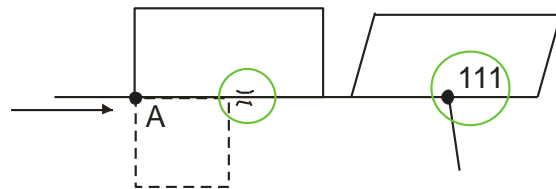

7. Example – SM doesn't begin in the point on the map, we must start execution of this SM in the nearest crossroad :

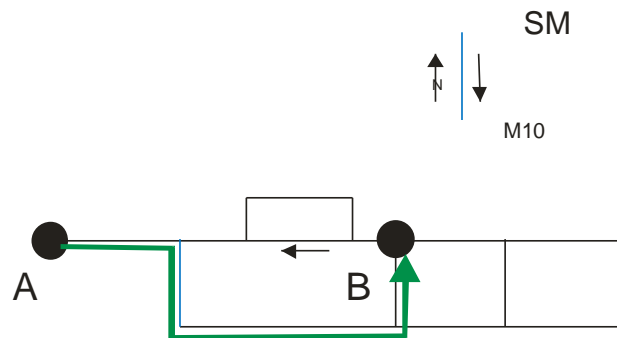
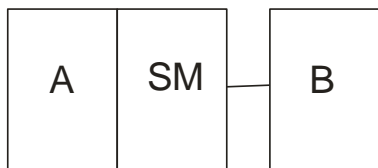

8. Example – SM begins in the declared point on the map, we must get to this declared point by real driving and start execution of this SM in the declared point :

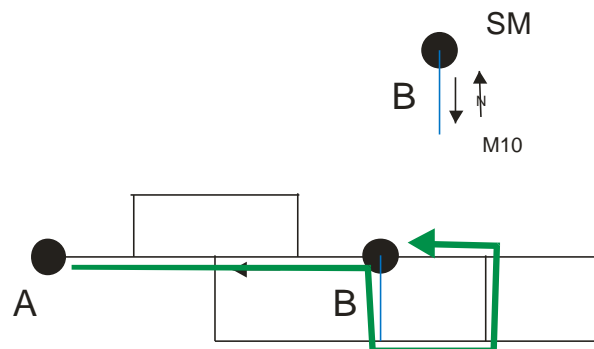
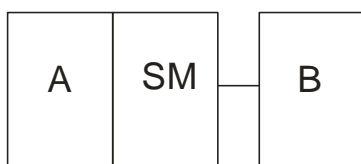

9. Example - Drawing SM into base map

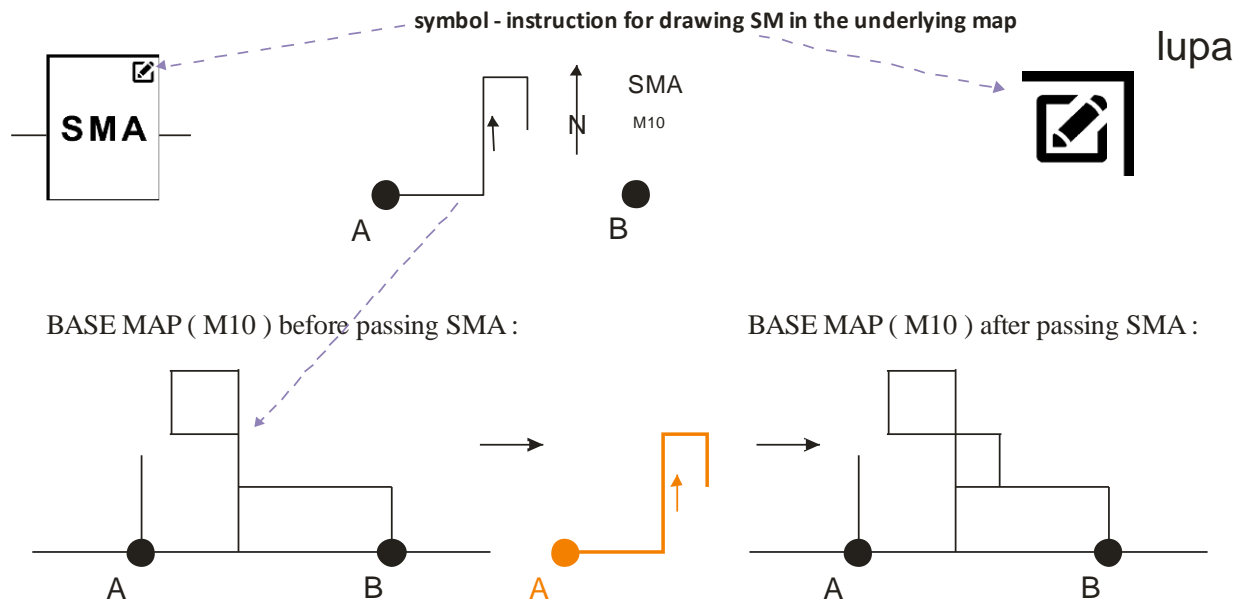

The track author has the option to have crews draw the SM into the base map, such as waypoints, bridges, etc... The SM must be the same scale as the base map. After completing the SM, the crew must draw the SM to the base map, the drawing of the SM is valid until the end of the stage. This rule then overwrites the existing situation on the base map (eg one-way streets can be reduced in size). It is only allowed to draw a SM (roads) on the map, not to delete a SM (roads) from the map.

Note : The SM is drawn on the base map ~~after the completion~~ **during the ride** of the SM, the drawing of the SM is valid until the end of the stage !!!

10. Example - Drawing SM into to the map according to the specification.

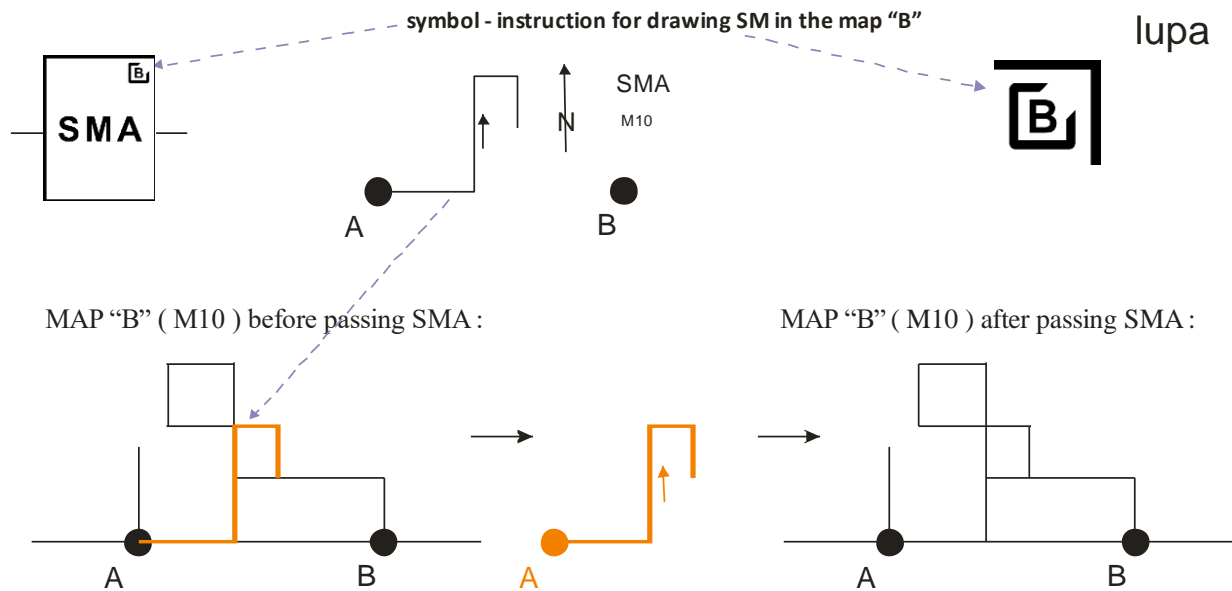

The track author has the option to have crews draw the SM on any map as specified. The SM must be to the same scale as the specification map to which the SM is instructed to be drawn. After completing the SM, the crew must draw the SM on the map according to the specification, the drawing of the SM is valid until the end of the stage. This rule then overwrites the existing map situation as specified (e.g. one-way streets can be reduced).

It is only allowed to draw a SM (path) on the map, not to delete a SM (path) from the map.

Note: The SM is drawn on the base map ~~after the completion~~ during the ride of the SM, the drawing of the SM is valid until the end of the stage !!!

11. Example - Drawing SM into to the map - example of correctly entered SM drawing on the map

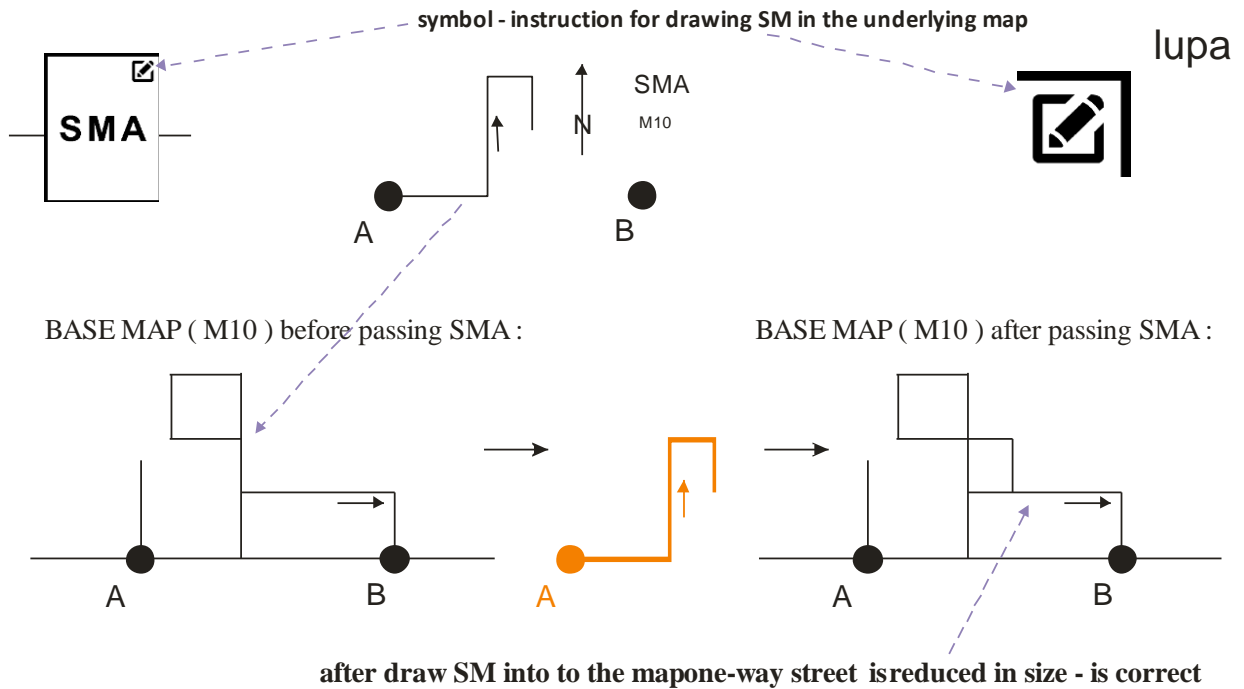

12. Example - Drawing SM into to the map - examples of **incorrectly** entered SM drawing on the map

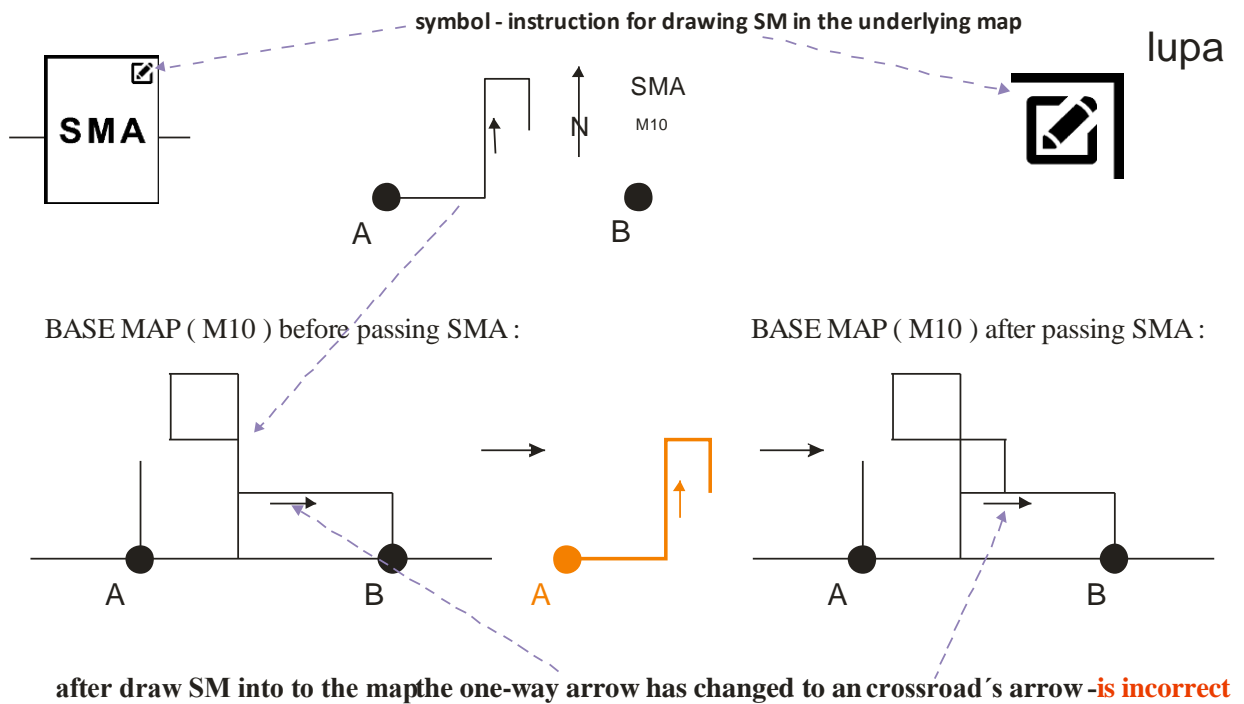

13. Example - Drawing SM into to the map - example of the possibility of turning at the end of the SM after its completion and drawing

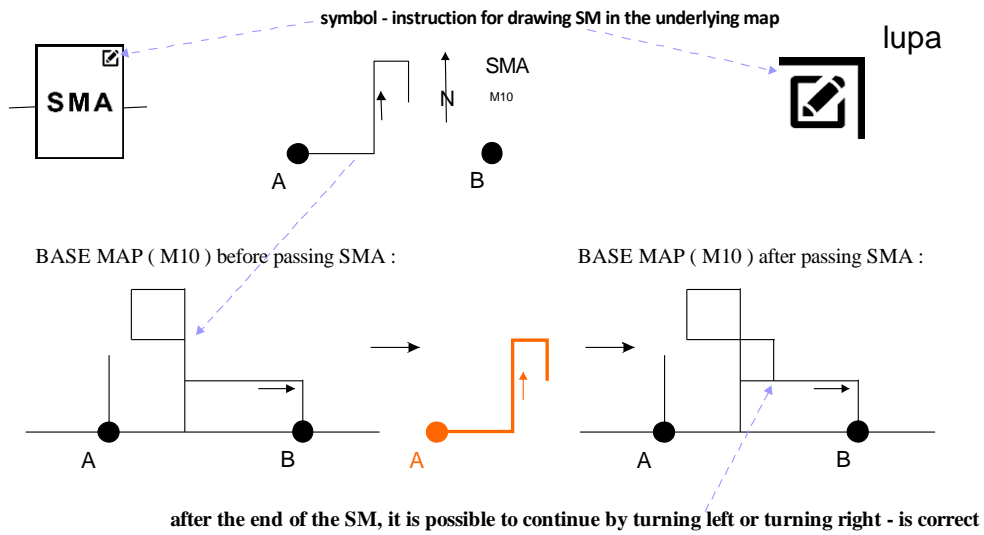

14. Examples :

1)

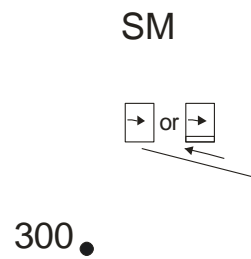
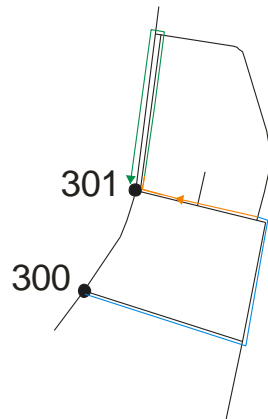
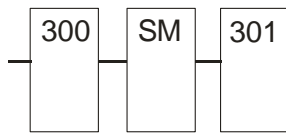

2)

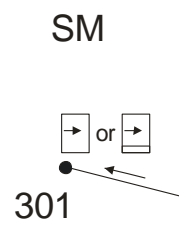
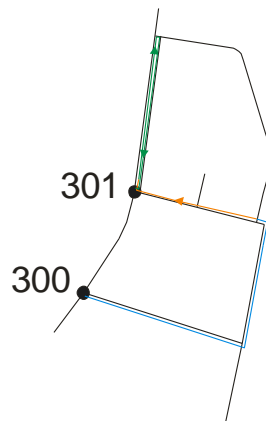
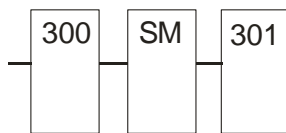

3)

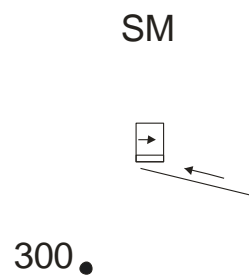
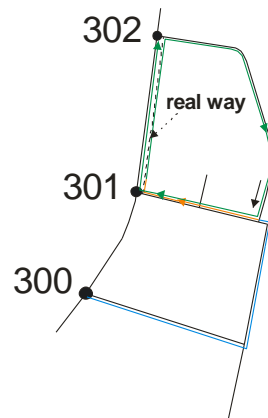
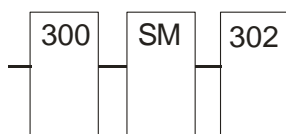

4)

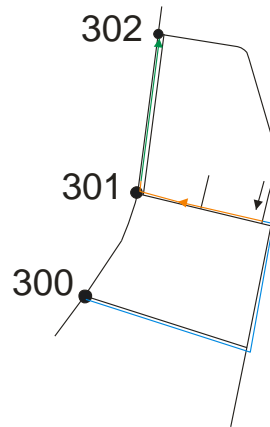
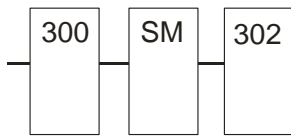

SM

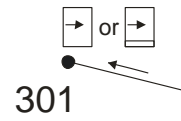

5)

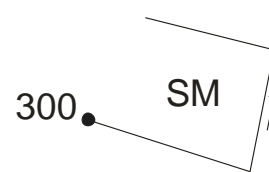
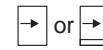
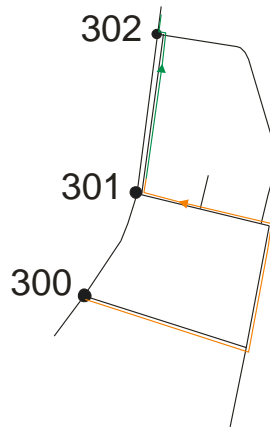
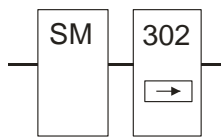

6)

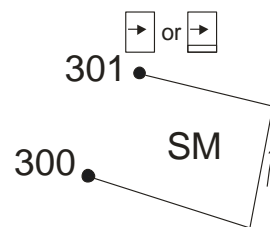
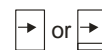
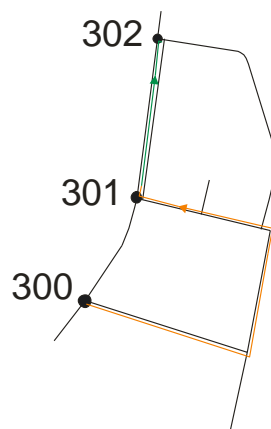
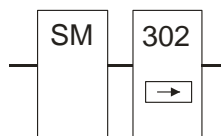

16.17. Leaving the map when passing a roundabout

Example 1 :

Leaving the map on a real roundabout that is not on the map you are driving – **correct entry** :

Itiner:

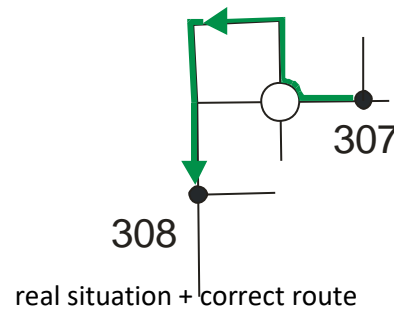
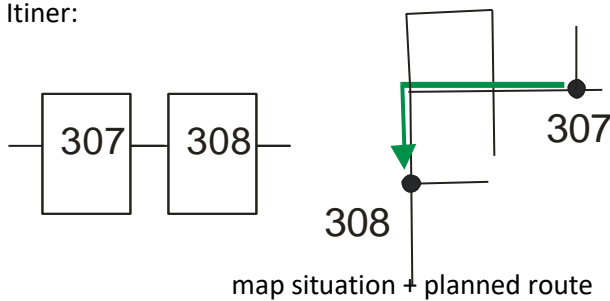

Itiner:

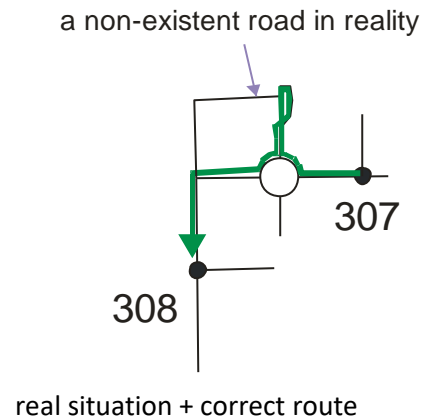
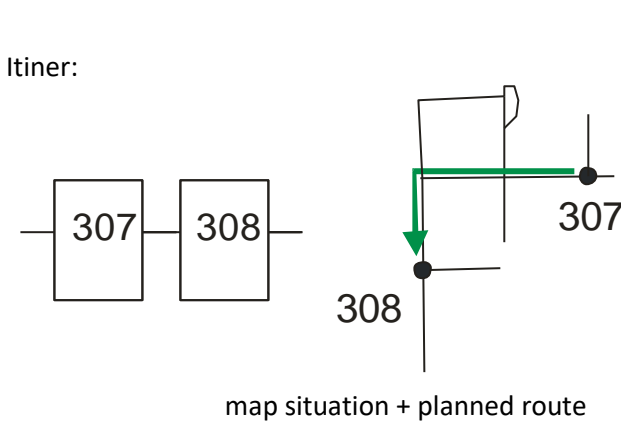

When planning the route on the map, I assume that the next intersection behind elevation 307 is classic intersection without roundabout. During the actual crossing, I find out that there is at the given intersection actually a roundabout. Since it is logically impossible to go straight through the roundabout, it happens the situation of leaving the map, when I continue realistically to the point where I connect to the map again. After reconnecting, I continue with the shortest map drive.

Example 2 :

Leaving the map on a real roundabout that is not on the map you are driving – **incorrect entry** :

Itiner:

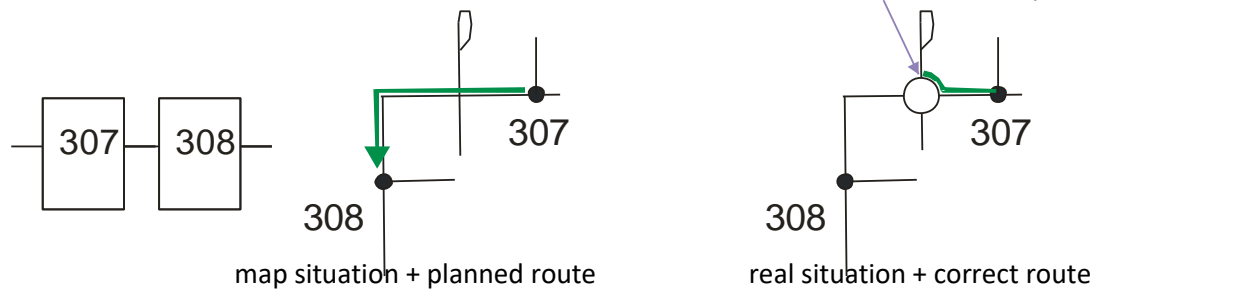

16.18. Other examples of special passings

– correct entry :

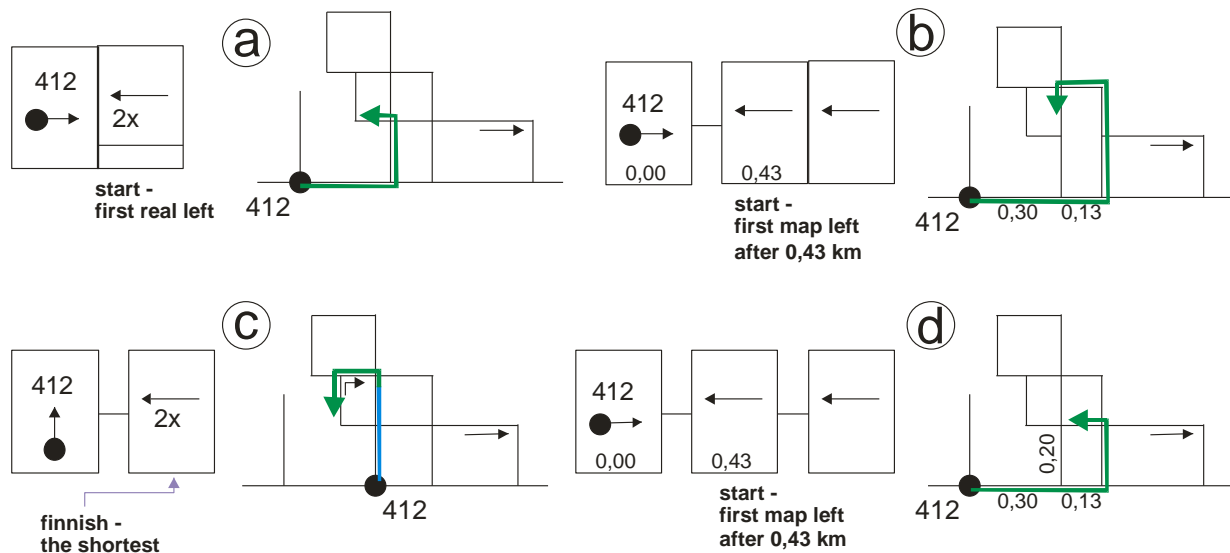

– **incorrect entry (It is not recommended to use) :**

